



Harsh & Hazardous

CONNECTIVITY SOLUTIONS

..... *Harsh and Hazardous Products*

HAWKE
International

KILLARK[®]



Vantage[®]
Technology



Ranging from 20A blade style to 200AMP pin & sleeve devices, Killark provides numerous and field proven solutions for safely supplying power to fixed and portable equipment in hostile environments.

Interchangeability with other manufacturers configurations provides user flexibility for real world applications. The range also has exclusive convenience features like breech-lock caps with “3rd Hand” notch.

Devices include plugs, receptacles, panel receptacles, and connectors to extend the reach of portable equipment. For personnel safety, ground fault protected receptacles, both portable and fixed, are available.

CONNECTORS

CONNECTIVITY INDEX

HAZARDOUS LOCATION

MULTI-PIN CONNECTORS



Hawke Connectors Overview 2-3

Hawke InstrumEx Control Connectors.. 4-9



Hawke ControlEx Control Connectors 10-15



Hawke PowerEx Control Connectors 16-21



Killark Acceptor UGP/UGR Series Power Connectors..... 22-25



Killark Acceptor UGRC Series Power Connectors.....26



Killark Acceptor UGRP Series Power Connectors.....27



Killark Acceptor UGRS Series Power Connectors.....28



Killark Acceptor UGRGF Series GFCI Power Connectors.....28



Killark Acceptor UGFI Series GFCI Power Connectors.....29



Killark VersaMATE VSQ Series Power Connectors.....30



Killark VersaMATE VSQ-FS Series Power Connectors.....31



Killark VersaMATE VBQ Series Power Connectors 32-33



Killark VersaMATE VSI Series Power Connectors 34-36



Killark KP/KR Series Power Connectors 37-40



Vantage XP Starline GD/SD/AF/SF Series Power/Control Connectors 42-55
Insert Configurations/Accessories 60-70



Vantage XP Starline GD Series Ground Power Connectors 56-59
Insert Configurations/Accessories 60-70

INDUSTRIAL LOCATION

MULTI-PIN CONNECTORS



Hawke FireMate Control Connectors71-72



Hawke ToughMate Control Connectors73-74



Killark VersaMATE VP/VR/VPR Series Power Connectors 75-83

SINGLE-PIN CONNECTORS



RigPower RMP11 Series 85-93



RigPower HP20 Series 95-101

Contact Page 121



COMMON FEATURES

There are several innovative features common across the range of Hawke connectors. Despite their highly advanced design and technical features, the range is extremely simple to use and quick to terminate.



Impossible to cross mate

The unique mechanical keying system prevents contact damage and ensures safe use by eliminating the possibility of misconnection of circuits. Machined key and keyway also ensures connector alignment



Ingress and deluge protected

All Hawke ATEX connectors meet the requirements of IP66 and IP67 to IEC60529. They are also deluge protected to DTS01 offering long term protection in onerous environments.



High reliability contacts

Each pin and socket is fitted with multilam technology to ensure reliable low resistance connection on each coupling.

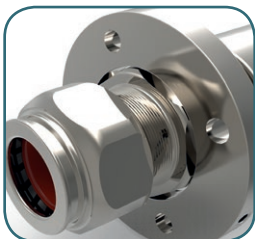

Retro fit flange option

Each connector plug and receptacle can be fitted with an optional mounting flange, either at point of order or retro fitted as required, allowing easy mounting of the connectors without the need to disassemble the units



Robust design

Designed and constructed for the most demanding environments, Hawke connectors are durable in almost any environment, requiring no routine maintenance to ensure continued performance.



SELECTION OVERVIEW

Hawke International connectors are ideal for use in hazardous areas commonly found in Oil and Gas exploration, production and process plants. Their features, however, also offer numerous benefits in explosive dust environments as well as harsh and hostile non-explosive applications where temporary but safe disconnection of power is critical. Hawke International's Ex range of connectors permit the safe and rapid service, repair and replacement of key plant, provide quick connection to temporary and permanent equipment and greatly reduce hook-up time in capital-intensive processes.

For a guide as to which Ex connector may be best suited to an individual application the table below outlines the main variables.

APPLICATION							
CONNECTOR TYPE	MINIMUM NUMBER OF PINS	MAXIMUM NUMBER OF PINS	MINIMUM CROSS SECTIONAL AREA OF CONDUCTOR MM ²	MAXIMUM CONDUCTOR MM ²	MAXIMUM VOLTAGE	MAXIMUM CURRENT (AMPS)	LIVE DEMATE
Instrum ^{Ex}	1	9	0.14	2.5	250V	10	✓
Control ^{Ex}	3	60	0.5	35	750V	125	X
Power ^{Ex}	1	4	50	630	750V*	780	X

* Other voltages available on special request.



INSTRUM^{Ex}

Tamb: -40°C to +60°C ^{Ex} II2 GD Exdbe IIC Extb IIIC Db T85
IP66, 67 & DTS01 deluge protected
Certificate No's Baseefa06ATEX0061X & IECEx BAS 06.0018X

This revolutionary design allows the live mate and de-mating of signal and low power in hazardous areas safely and quickly. The Instrum^{Ex} connector is available in two sizes. The 4-way and the 9-way options will accept cores ranging between 0.5mm² and 2.5mm² and can operate up to a maximum current of 10A (AC1) at 250V AC and 2.5A (DC1) 60V DC. The 8-way option, designed predominantly for Ethernet applications, will accept cores ranging between 0.14mm² and 0.37mm² and can carry 1A (AC1) at 60V AC and 0.5A (DC1) 60V DC. Instrum^{Ex} connectors include an integral Hawke cable gland for easy termination of both armoured and un-armoured cables.



CONTROL^{Ex}

Tamb: -40°C to +60°C ^{Ex} II2 GD Exdb IIC Gb, Extb IIIC T95Db
IP66, 67 & DTS01 deluge protected
Certificate No's Baseefa12ATEX0144X & IECEx BAS 12.0006X

The 4th generation of Control^{Ex} connectors include many features and refinements as a result of consumer feedback, which makes them particularly suitable for control and low/medium power applications. The robust stainless steel body can hold up to 60 contacts and will accept conductor sizes ranging between 0.5mm² and 35mm², operating up to 125A and 750V.



POWER^{Ex}

Tamb: -40°C to +60°C ^{Ex} II2 GD Exdb IIC Extb IIIC Db T85
IP66, 67 & DTS01 deluge protected
Certificate No's Baseefa06ATEX0062X & IECEx BAS 06.0019X

The Power^{Ex} range of connectors have been designed specifically for the extremely demanding requirements of higher power applications. Inserts are available with 1 to 4 contacts with a conductor acceptance range of between 50mm² and 630mm² operating up to 780A and 750V as standard. Other voltages available on special request.



FEATURES

Tamb: -40°C to +60°C. II2 GD Exdbe IIC Gb Extb IIIC Db T85
IP66, 67 and DTS01 deluge protected.
Certificate No's Baseefa06ATEX0061X and IECEx BAS 06.0018X.

Bulkhead Receptacle (BR)

Connector Plug (CP)

Connector Receptacle (CR)

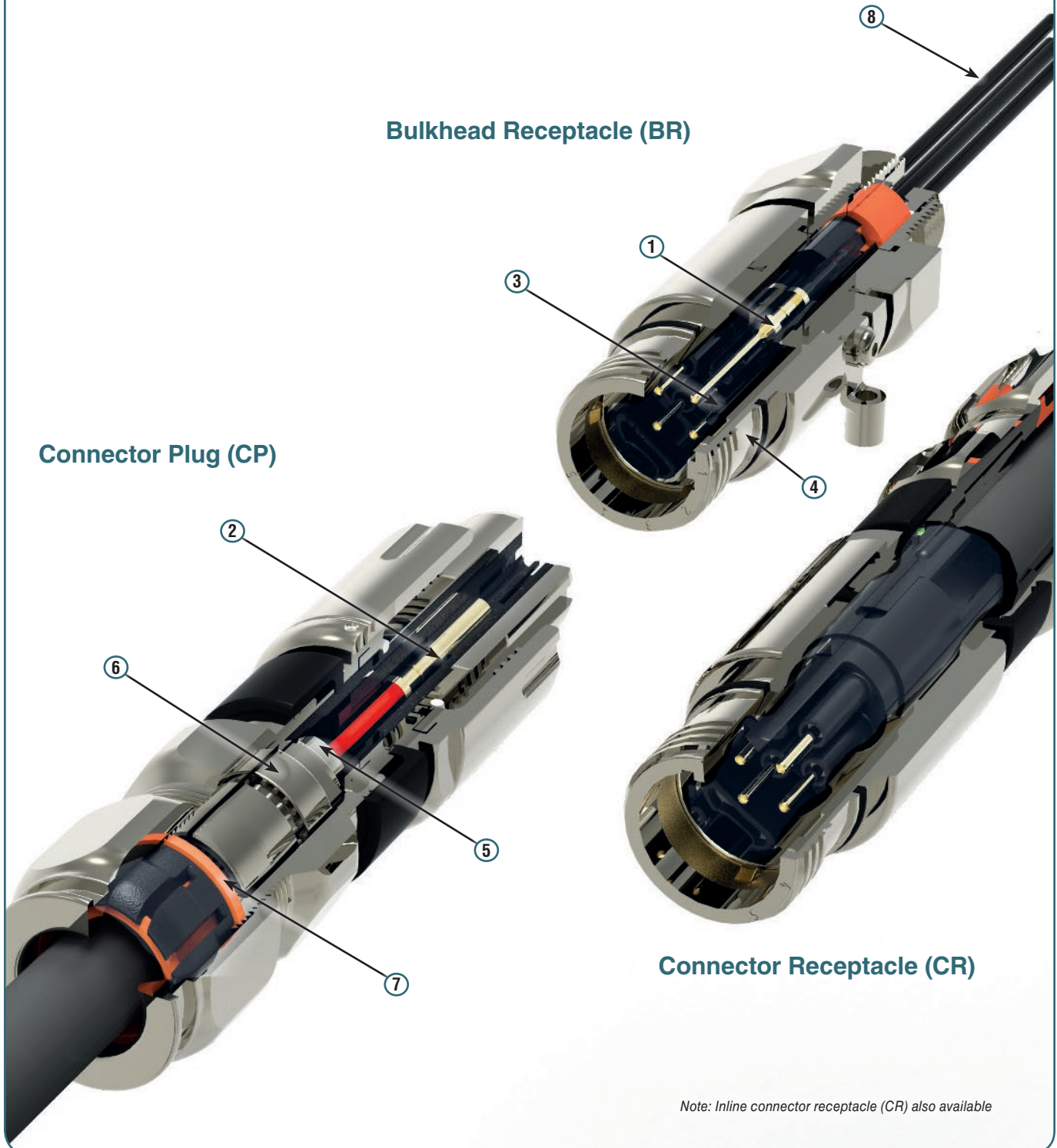

Note: Inline connector receptacle (CR) also available

FEATURES



1
Electrical Insert with Key
Easy to assemble electrical insert allows crimped or soldered connections.



5
Anti-rotation
Profiled Spigot and connector body prevent cable rotation, eliminating cable damage.



2
Keyed Positions
Secondary keying on the actual insert bodies guarantees contact alignment, preventing pin damage.



6
Reversible Armour Clamp
The Instrum^{EX} incorporates Hawke's proven and patented armour termination method to accommodate different types of armour or braid.



3
Integral Keying
Machined key and keyway ensures connector alignment. Unique 5 position insert keying system prevents cross-mating.

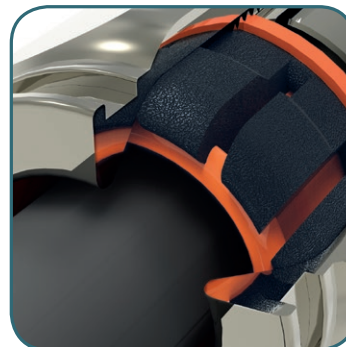

7
Versatile LSFZH Rear Seal
Accommodates a wide range of cable sizes and provides highly effective cable grip and ingress protection.

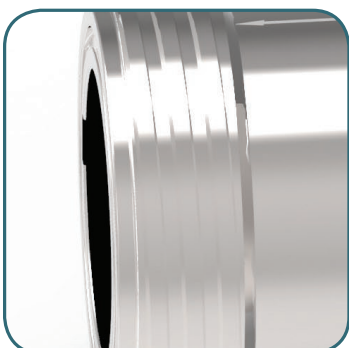

4
Quick Connect
Unique 4 start ACME thread offers a smooth and quick fully mating action in less than two turns. Earth continuity is achieved via a 360° contact clip.

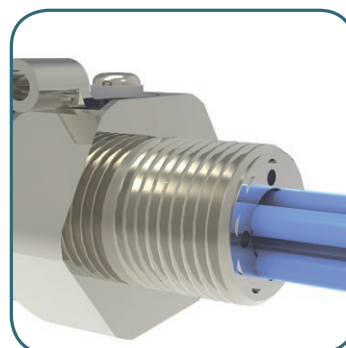

8
Pre-terminated
All BR connectors are supplied with pre-terminated tails to suit your requirements.

HOW IT WORKS

The Instrum^{Ex} connectors are designed to provide ease of installation and speed of use whilst providing a flexible, safe and reliable method for **mating and disconnection of circuits which are energised**.

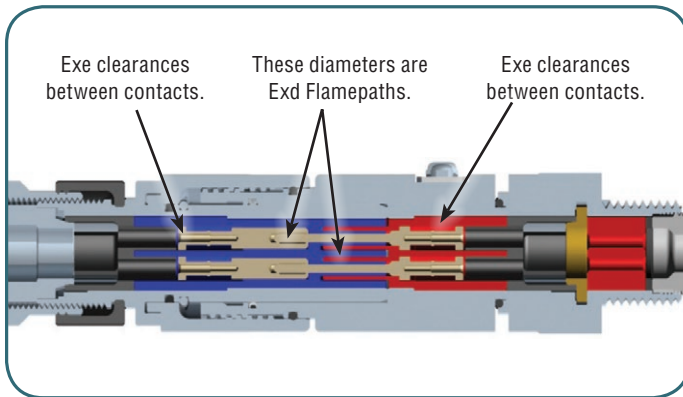

Stage 1

The two mating halves are easily engaged and disengaged by two full turns of the ACME custom engaging thread, during which time the pins and socket are protected by the Exd flameproof protection concept. The outer shell of the connector combined with the integral Hawke cable gland seal ensure that the internal connections are protected to the Exe increased safety protection concept.

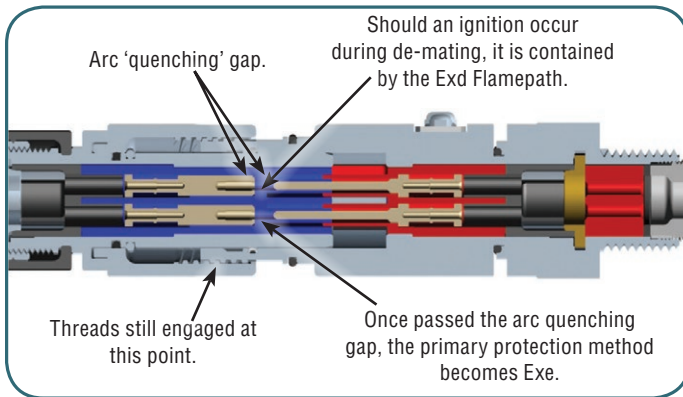

Stage 2

During connector engagement and disengagement any sparking of the contacts is contained within an arc 'quenching section' which is housed within the Exd flamepath areas.

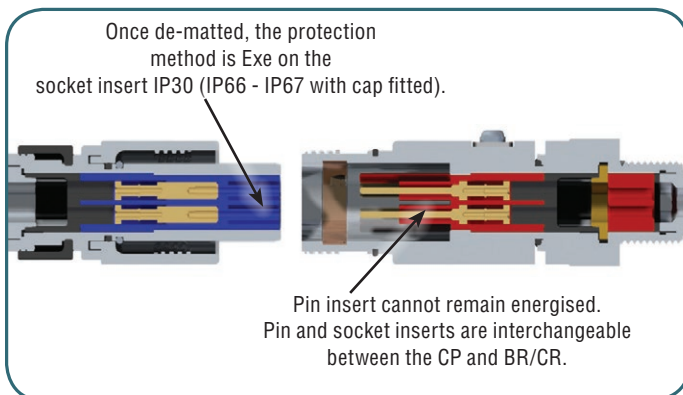

Stage 3

When the connector halves are disengaged, the socket section is protected to IP30 and must have the protective cap fitted immediately to restore the full Exe increased safety requirements and IP rating. The pins and socket inserts are interchangeable between all three connector components: i.e. Bulkhead receptacle, in-line receptacle and connector plug. **In all installations, the "live" side of the connector must always contain the socket insert.**

INSERTS

Front View of Socket Insert

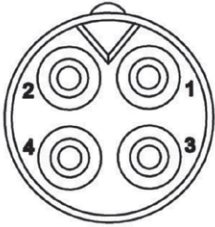

4 x 0.5 - 1mm²
4 x 1.5 - 2.5mm²

Back View of Socket Insert

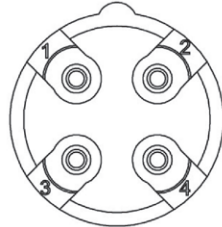

4 x 0.5 - 1mm²
4 x 1.5 - 2.5mm²

Front View of Pin Insert

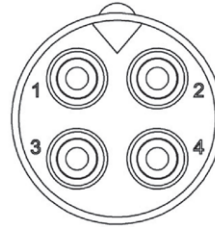

4 x 0.5 - 1mm²
4 x 1.5 - 2.5mm²

Back View of Pin Insert

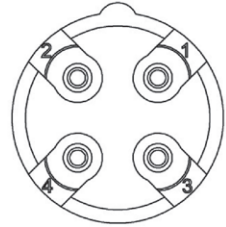

4 x 0.5 - 1mm²
4 x 1.5 - 2.5mm²

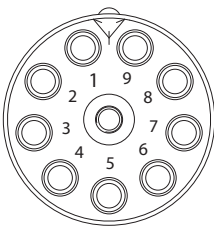

9 x 0.5 - 1mm²
9 x 1.5 - 2.5mm²

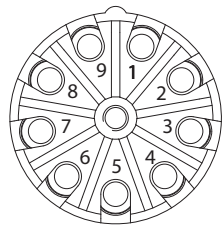

9 x 0.5 - 1mm²
9 x 1.5 - 2.5mm²

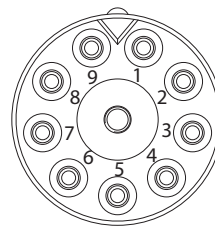

9 x 0.5 - 1mm²
9 x 1.5 - 2.5mm²

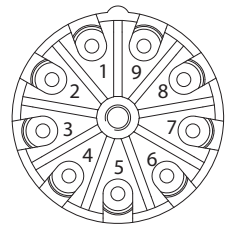

9 x 0.5 - 1mm²
9 x 1.5 - 2.5mm²

Front View of Socket Insert

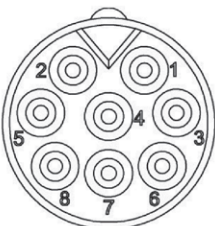

8 x 0.14 - 0.37mm²

Back View of Socket Insert

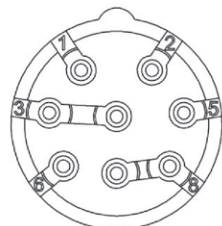

8 x 0.14 - 0.37mm²

Front View of Pin Insert

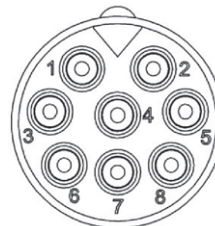

8 x 0.14 - 0.37mm²

Back View of Pin Insert

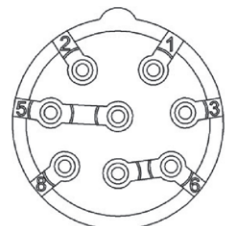

8 x 0.14 - 0.37mm²

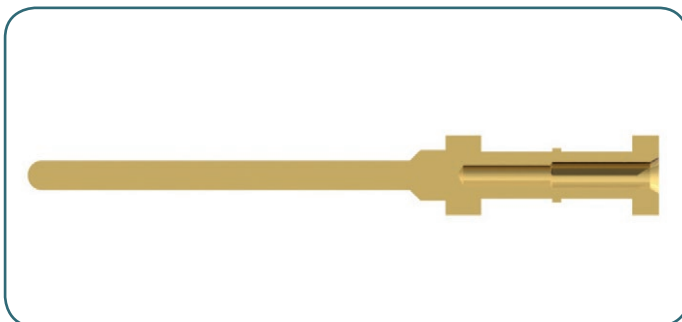

Dual Crimp

Two crimping locations on the 4 & 9 way contacts allow for only two contact sizes to cover a far greater range than conventional contacts. This allows termination of cores ranging between 0.5 and 2.5mm².

Contacts must be crimped using the Hawke supplied crimping tool part No. HCT1.



ORDER CODE

When ordering, select relevant code from each block as shown in the example below: **Instrum** / **N-BR1-M-B-P-X-0-4-X-A**

	SELECT CODE	DESCRIPTION	EXAMPLE CODE
MATERIAL	N	Nickel Plated Brass	N
	S	Stainless Steel	
CONNECTOR STYLE	CP	Connector Plug	BR1
	FP	Flange Mounted Connector Plug	
	CR	Connector Receptacle	
	FR	Flange Mounted Connector Receptacle	
	BR1	Bulkhead Receptacle (Fixed Position 1 Standard)	
	BR2	Bulkhead Receptacle (Fixed Position 2)	
	BR3	Bulkhead Receptacle (Fixed Position 3)	
	BR4	Bulkhead Receptacle (Fixed Position 4)	
	BR5	Bulkhead Receptacle (Fixed Position 5)	
BULKHEAD ENTRY THREAD	M	Metric Thread (M20 4/8-way / M32 9-way)	M
	N	NPT Thread (1/2" for 4/8-way / 3/4" 9-way)	
	R	NPT Alternative Thread (3/4" for 4/8-way / 1" 9-way)	
	X	N/A (for Connector Plug or Connector Receptacle)	
CROSS SECTIONAL AREA	A	4 x 0.5 - 1mm ² *	B
	B	4 x 1.5 - 2.5mm ² *	
	C	8 x 0.14 - 0.37mm ²	
	D	9 x 0.5 - 1mm ²	
	E	9 x 1.5 - 2.5mm ²	
<i>* 4 way Bulkhead Receptacle will always be pre-terminated with 1.5mm² conductors, irrespective of cross sectional area.</i>			
INSERT TYPE	P	Pin Insert **	P
	S	Socket Insert **	
<i>** Note: In all installations the "live" side of the connector must always contain the socket insert.</i>			
OUTER SHEATH DIAMETER	S	Cable Gland Seal 5.5 - 16mm (4-way/8-way)	X
	A	Cable Gland Seal 12.5 - 20.5mm (9-way)	
	B	Cable Gland Seal 16.9 - 26mm (9-way)	
	X	N/A (Bulkhead Receptacle)	
BULKHEAD RECEPTACLE CABLE LENGTH	0	0.5m (Standard)	0
	1	1m	
	2	2m	
	C	Customer Specified	
	X	N/A (for Connector Plug and Receptacle)	
BULKHEAD RECEPTACLE PIN QUANTITIES #	4	4 (pins 1-4 terminated) Standard 4-way BR#	4
	3	3 (pins 1,2 & 3 terminated)#	
	8	8 (pins 1-8 terminated) Standard 8-way BR#	
	9	9 (pins 1-9 terminated) Standard 9-way BR#	
	C	Customer Specified	
	RJA	RJ45 Jack fitted, wired to T-568A	
	RJB	RJ45 Jack fitted, wired to T-568B	
	RJC	Customer Specified	
	X	N/A (for Connector Plug and Receptacle)	
<i># Bulkheads also include an additional earth lead.</i>			
ARMOUR CLAMP SIZE	R	Alternative Clamping Rings B only	X
	X	N/A (Bulkhead Receptacle)	
	S	Standard Clamping Ring O,A,B	
	U	Unarmoured/Copper Braid Clamp (in addition to Clamping Rings)	
<i>** Note: See Clamping Ring table on page 59.</i>			
CERTIFICATION	A	ATEX/IECEx/EAC/Inmetro/NEC505	A

DIMENSIONS

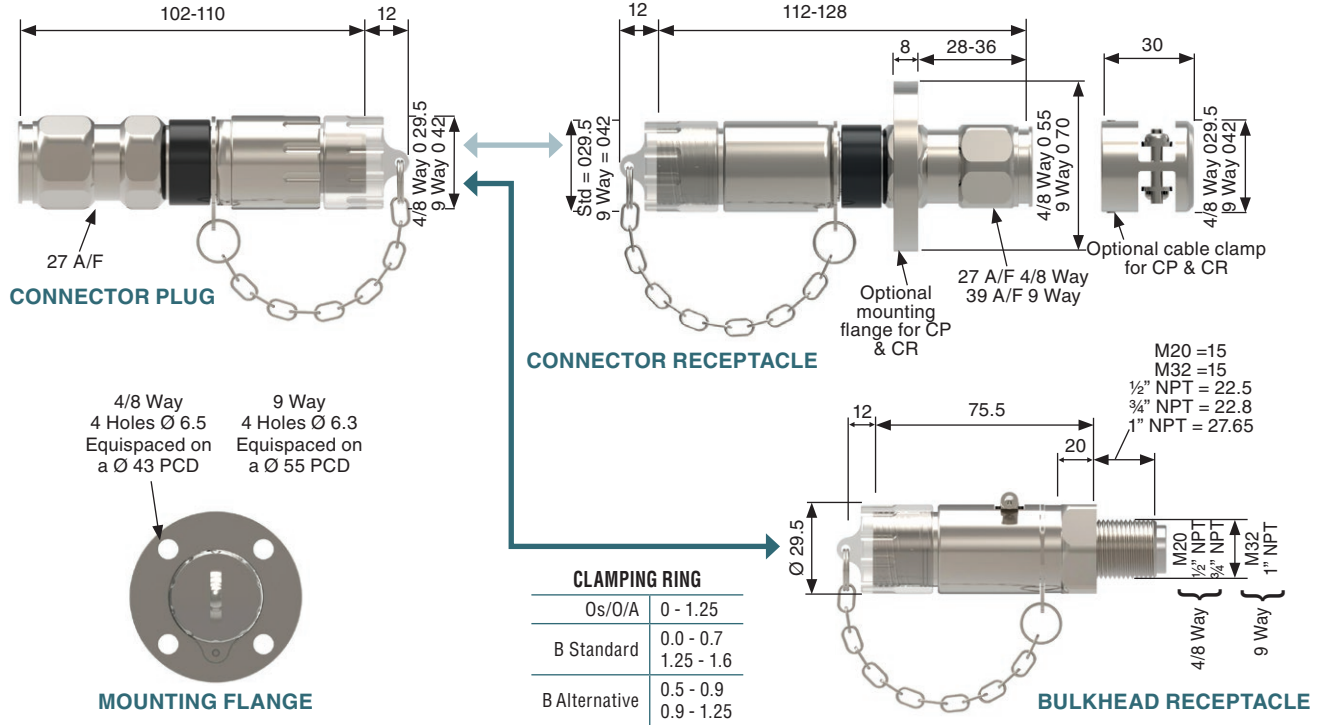

All dimensions in mm unless otherwise stated.

TECHNICAL DATA - 4 WAY / 9 WAY	
EXPLOSION PROTECTION	⊕ II2 GD Exdbe IIC Gb Extb IIIC Db T85°C
AMBIENT TEMPERATURE	-40°C to +60°C
CERTIFICATION	Baseefa 06 ATEX 0061X
	IECEX BAS06.0018X
RATINGS 4 / 9 WAY	Voltage AC 250V RMS
	Current AC EN 60947-4-3 10A (AC21)
	Current AC EN 60947-4-1 10A (AC1)
	Current AC EN 60947-4-1 1A (AC3)
	Frequency 50/60 Hz
	Power Factor 0.9
	Voltage DC 60V
	Current DC EN 60947-4-3 2.5A (DC21)
Current DC EN 60947-4-1 2.5A (DC1)	
Current DC EN 60947-4-1 0.5A (DC3)	
FUSE RATING 4 / 9 WAY	10 amp without thermal protection
	20A gL with thermal protection
MAX NO. OF MAKE & BREAK OPERATIONS (EN61984)	On load 150
	Off load 500
IP RATING	IP66, IP67 and DTS01 deluge protected. <i>Note: Caps to be fitted to maintain IP ratings when the connector halves are separated.</i>
STORAGE TEMPERATURE	-50°C to +70°C

TECHNICAL DATA - 8 WAY	
EXPLOSION PROTECTION	⊕ II2 GD Exdbe IIC Gb Extb IIIC Db T85°C
AMBIENT TEMPERATURE	-40°C to +60°C
CERTIFICATION	Baseefa 06 ATEX 0061X
	IECEX BAS06.0018X
RATINGS 8 WAY	Voltage AC 60V RMS
	Current AC EN 60947-4-3 1A (AC21)
	Current AC EN 60947-4-1 1A (AC1)
	Current AC EN 60947-4-1 0.1A (AC3)
	Frequency 50/60 Hz
	Power Factor 0.9
	Voltage DC 60V
	Current DC EN 60947-4-3 0.5A (DC21)
Current DC EN 60947-4-1 0.5A (DC1)	
Current DC EN 60947-4-1 0.1A (DC3)	
FUSE RATING 8 WAY	0.5 amp without thermal protection
	1A gL with thermal protection
MAX NO. OF MAKE & BREAK OPERATIONS (EN61984)	On load 150
	Off load 500
IP RATING	IP66, IP67 and DTS01 deluge protected. <i>Note: Caps to be fitted to maintain IP ratings when the connector halves are separated.</i>
STORAGE TEMPERATURE	-50°C to +70°C



FEATURES

Tamb: -40°C to +60°C ^{Ex} II2 GD Exdb IIC Gb, Extb IIIC Db T95
IP66, 67 & DTS01 deluge protected
Certificate No's Baseefa12ATEX0014X & IECEx BAS 12.0006X.



Connector Plug-CP



Bulkhead-BR



Connector Receptacle - CR

FEATURES



1 Easy Fieldwireable

Pin and socket inserts are numbered front and back to assist wiring and avoid termination errors. Crimp and solder inserts available.



5 Running Coupler

Allows the connector to be installed onto a pre-assembled cable gland. Connector is rear loading and includes locking engaging nut.

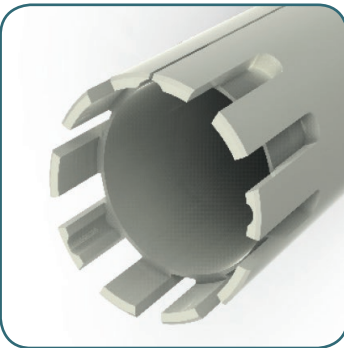

2 Internal Keyway Spacer

Eases accessibility for termination as tube fitted after termination complete, along with allowing easy installation into the required keyed position (See 4)

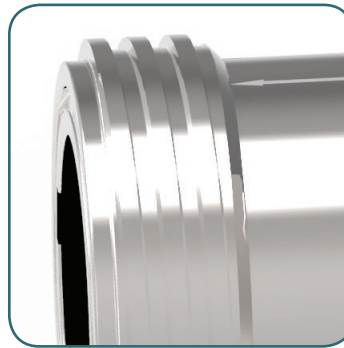

6 Acme Thread at Mating Interface

Unique ACME thread offers a smooth and quick fully mating action.

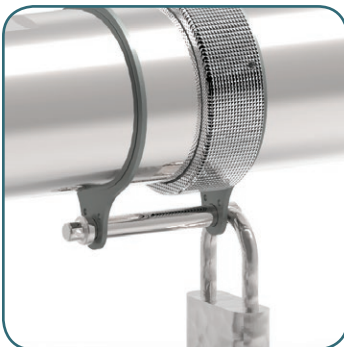

3 Locking Pin

Optional locking pin provides the facility for mated connectors to be permanently locked, via the use of a padlock, ensuring they cannot be separated under load. *(Padlock not supplied)*



7 Fully Inspectable Flameproof Barrier

Provides direct inspection of the flameproof seal and offers users the peace of mind that the connector is safe for installation.



4 Keying Position

The unique visual 5 position insert keying system (3 on Ex16) along with the integral machined keyways prevent contact damage and ensures safe use by eliminating the possibility of misconnection of adjacent circuits.

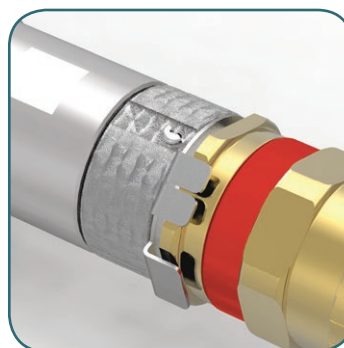

8 Anti-Rotation Device

Connector plugs and receptacles come complete with anti-rotation ring, which when fitted between the connector and gland, helps to eliminate the possibility of the gland loosening, locking this in position.



INSERTS

INSERT SIZE	INTERNAL DIAMETER OF CUP (MM) NOMINAL	
	SOLDERED	CRIMPED
1.5mm ²	2	2
2.5mm ²	3	3
6mm ²	3.5	3.2
10mm ²	7	4
16mm ²	7	5
25mm ²	8	6.5
35mm ²	8	8.3

INSERT SELECTION TABLE					
CONFIGURATION					
SHELL SIZE 16	SHELL SIZE 25	SHELL SIZE 32	SHELL SIZE 40	SHELL SIZE 50	SHELL SIZE 63
3 x 1.5mm ² + Earth	4 x 1.5mm ² + Earth	12 x 1.5mm ² + Earth	24 x 1.5mm ² + Earth	37 x 1.5mm ² + Earth	49 x 1.5mm ² + Earth
4 x 1.5mm ² + Earth	9 x 1.5mm ² + Earth	19 x 1.5mm ² + Earth	30 x 1.5mm ² + Earth	27 x 2.5mm ² + Earth	60 x 1.5mm ² + Earth
-	12 x 1.5mm ² + Earth	10 x 2.5mm ² + Earth	19 x 2.5mm ² + Earth	13 x 6mm ² + Earth	37 x 2.5mm ² + Earth
-	4 x 2.5mm ² + Earth	12 x 2.5mm ² + Earth	4 x 25mm ² + Earth	-	-
-	7 x 2.5mm ² + Earth	4 x 6mm ² + Earth	4 x 35mm ² + Earth	-	-
-	4 x 6mm ² + Earth	6 x 6mm ² + Earth	-	-	-
-	-	3 x 10mm ² + Earth	-	-	-
-	-	4 x 10mm ² + Earth	-	-	-
-	-	3 x 16mm ² + Earth	-	-	-
-	-	4 x 16mm ² + Earth	-	-	-

Note: Inserts for use in bulkhead receptacles are solder termination only for contact sizes of 6mm² and above.

Hawke Control connectors have a maximum working voltage of 660V DC (660V AC) as standard. 3rd & 4th generation Control connectors can be connected together within certification.

Other voltages available on special request.

CONNECTORS

CONTROL 



CODE

Hawke International does not recommend the use of their ControlEx Connectors in applications where rigid PVC/SWA/PVC power cabling (typically to BS 6346 standards or equivalents) is used in portable/semi-portable applications.

When ordering, select relevant code from each block as shown in the example below:

ControlEx / Exd-32-S-CP-V-19 x 1.5-S-C-FL-FPC-P-R25-A-1-T

CONTROL 	SELECT CODE	DESCRIPTION	EXAMPLE CODE
PROTECTION	Exd	Flameproof	EXD
SHELL SIZE	16	16	32
	25	25	
	32	32	
	40	40	
	50	50	
	63	63	
MATERIAL	S	Stainless Steel	S
CONNECTOR STYLE	CP	Connector Plug	CP
	CR	Connector Receptacle	
	BR	Bulkhead Receptacle	
KEYING SYSTEM	V	Variable Keyway (All)	V
	F	Fixed Keyway (only available if purchasing terminated)	
NUMBER OF CONTACTS		See Insert Selection Chart	19
	X	No Insert	
CONTACT SIZE		See Insert Selection Chart	1.5
INSERT TYPE	P	Pin	
	S	Socket	
	X	No Insert	S
TERMINATION STYLE	S	Solder*	
	C	Crimp*	
	X	No Insert	C
FLANGE TYPE [♦]	FL	Mounting Flange	
<i>Note: CP or CR only - one per mating pair.</i>	SF	Split Flange (can be retro fitted after termination)	FL
CAP TYPE	FRC	Flameproof Receptacle Cap	
	FPC	Flameproof Plug Cap	FPC
	PRC	Plastic Receptacle Cap	
	PPC	Plastic Plug Cap	
LOCKING PIN [♦]	P	Locking Pin (only one required per mating pair)	
ALTERNATIVE CABLE GLAND ENTRY [♦]	R20	Reduced Cable Gland Entry M20 (Ex 25 only)	R25
	R25	Reduced Cable Gland Entry M25 (Ex 40 & Ex 32 only)	
	R32	Reduced Cable Gland Entry M32 (Ex 50 & Ex 40 only)	
	R40	Reduced Cable Gland Entry M40 (Ex 63 & Ex 50 only)	
	R50	Reduced Cable Gland Entry M50 (Ex 63 only)	
CERTIFICATION	A	ATEX/IECEx/EAC/INMETRO	A
	N	ATEX/IECEx/EAC/INMETRO / NEC 505 Voltage reduced to 600V	
AMBIENT RATING AND TEMPERATURE CLASS	1	T5 +40°C Standard	1
	2	T5 +50°C	
	3	T5 +60°C	
	4	T6 +40°C	
	5	T6 +50°C	
	6	T6 +60°C	
<i>T5 +40°C will be supplied as standard if alternative not specified.</i>			
TERMINATION [♦]	T	Termination Required	T

[♦] If not required, omit selection character from order code.

DIMENSIONS

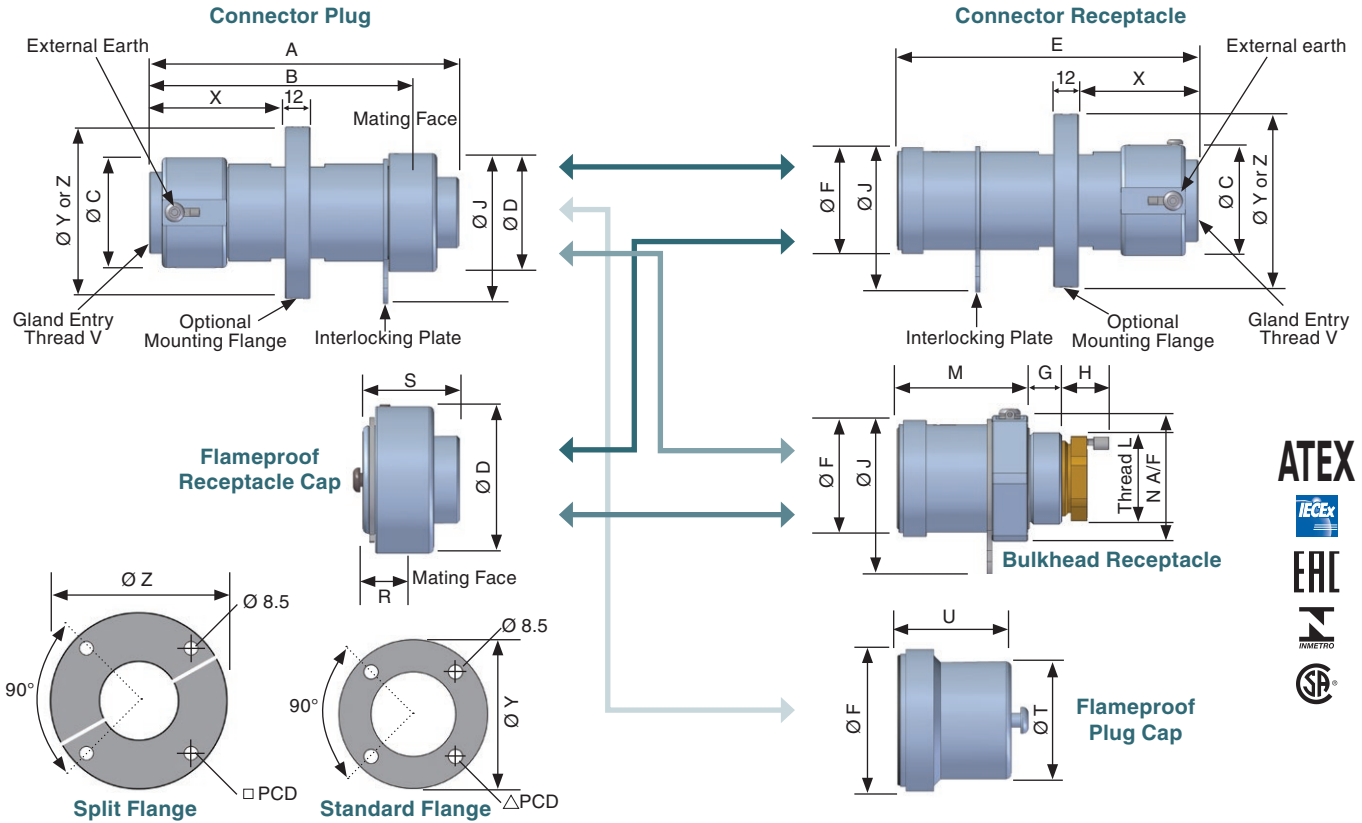

The flameproof cap must be fitted to the connector before the power is restored to the disconnected circuit. The receptacle cap and plug cap are available in acetal and provide an IP rating of IP66/67. They may only be used when the socket or plug is not re-energised following disconnection.

For connector plugs and connector receptacles cable glands are required to terminate incoming cables. Hawke recommend the ICG 653/UNIV cable gland is used.

HAWKE EX SERIES DIMENSIONS (MM)						
DIMENSION	EX16	EX25	EX32	EX40	EX50	EX63
A	127	152	152	152	152	148
B	105	128	129	129	129	126
Ø C	36	46	53	60	66	83
Ø D	37	49	57	65	76	90
E	128	152	152	152	152	152
Ø F	32	45	51	59	70	83
G	15	15	15	15	15	15
H (nominal)	20	20	20	20	20	20
J (Aperture Clearance Hole)	55	65	75	85	95	115
*Thread L (1.5mm Pitch)	M25	M32	M40	M50	M63	M75
M	54	54	56	56	56	56
N A/F	36	46	55	65	80	95
R	15	15	15	16	16	17
S	38	38	38	39	39	40
Ø T	28	34	42	51	60	73
U	40	40	40	40	40	40
Thread V (1.5mm Pitch)	M20	M25	M32	M40	M50	M63
X (nominal)	54	70	70	70	70	67
Ø Y	66	76	83	91	102	117
Δ	49	59	66	74	85	100
Ø Z	87	99	105	117	129	147
□	70	82	88	100	112	130

*Bulkhead entry thread L can be adapted to other sizes. This may affect the overall length of unit.

CALCULATIONS

To select the shell size of the connector, it is essential that you calculate the dissipated wattage of the arrangement. This ensures that the arrangement does not exceed the maximum permitted temperature classification with regard to the upper ambient temperature for the area of installation. (Please refer to table 1 for the maximum allowable dissipated wattage per connector size).

TABLE 1						
CONNECTOR SIZE	UPPER AMBIENT TEMPERATURE OF +40°C		UPPER AMBIENT TEMPERATURE OF +50°C		UPPER AMBIENT TEMPERATURE OF +60°C	
	TEMPERATURE CLASS		TEMPERATURE CLASS		TEMPERATURE CLASS	
	T6	T5	T6	T5	T6	T5
Ex16	5W	7W	4W	6W	2.6W	4.6W
Ex25	8W	11W	6W	10W	4W	7W
Ex32	10.5W	14.5W	8W	12W	5.4W	9W
Ex40	12W	17W	9W	14W	5.5W	10.5W
Ex50	13W	20W	10W	17W	6.5W	12.5W
Ex63	17W	29W	13W	24W	8.5W	17W
Maximum allowable dissipated wattage						

TABLE 2			
CONTACT SIZE	COMBINED CABLE AND CONTACT RESISTANCE (OHMS)		CONTACT CURRENT RATING
	SOLDERED	CRIMPED	
1.5mm ²	0.0166 Ω	0.0173 Ω	10 amps
2.5mm ²	0.0102 Ω	0.0109 Ω	17 amps
6mm ²	0.0047 Ω	0.0054 Ω	30 amps
10mm ²	0.0027 Ω	0.0033 Ω	78 amps
16mm ²	0.0018 Ω	0.0024 Ω	78 amps
25mm ²	0.0012 Ω	0.0018 Ω	125 amps
35mm ²	0.0009 Ω	0.0015 Ω	125 amps

Other ambient temperature options can be extrapolated from Table 1 above, or contact Hawke International for more information.

Dissipated wattage calculation

Equation Definitions

- W = Dissipated wattage factor of the connector
- N = The number of conductors to be terminated/number of contacts required. (Note: A contact comprises of a pin and socket).
- I = The current requirement per contact. (Note: This must be equal to or less than the maximum current rating of the contact, as shown in table 2).
- R = The combined cable and contact resistance (see table 2)

Values pertinent to these definitions must then be input into the following equation to calculate the dissipated wattage (w) of your chosen arrangement:

$$W = N \times I^2 \times R$$

(Note: The results must be lower than the maximum figure shown in table 1 for the appropriate temperature class and ambient temperature).

e.g. T6 40°C ambient application with 9 x 1.5mm² conductors, running at 7 amps.

N = 9 contacts I = 7 amps R = 0.0166Ω (1.5mm² soldered combined cable and contact resistance)

Therefore W = 9 x 49 x 0.0166Ω = 7.32 watts.

Therefore, an Ex25 Connector should be specified for this application as the shell size can accommodate the required 9 x 1.5mm² pin/socket inserts (SEE PAGE 56 - Insert Selection Table) and the resultant dissipated wattage (7.32 watts) is below the maximum permitted 8 watts (See Table 1).

This equation can also be transposed to facilitate the calculation of the maximum number of conductors permitted in your selected connector ① and the maximum allowable current within the upper ambient temperature of our location ②.

$$\textcircled{1} \quad N = \frac{W}{R \times I^2}$$

$$\textcircled{2} \quad I = \sqrt{\frac{W}{N \times R}}$$

(Note: The result of equation ② must not exceed the maximum current rating of contacts (see table 2).

Note: Unless otherwise requested, connectors will be marked as T5 with an upper ambient temperature of +40°C.



FEATURES

Tamb: -40°C to +60°C. II2 GD Exdb IIC Gb, Extb IIC Db T85
IP66, 67 and DTS01 deluge protected
Certificate No's Baseefa06ATEX0062X and IECEx BAS 06.0019X.

Connector Receptacle - CR

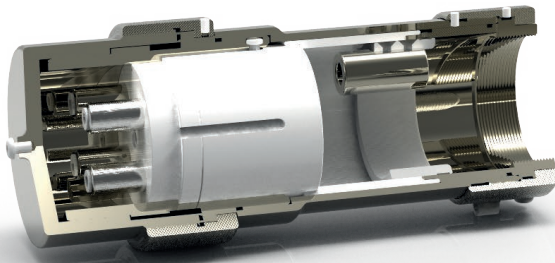

Connector Plug-CP

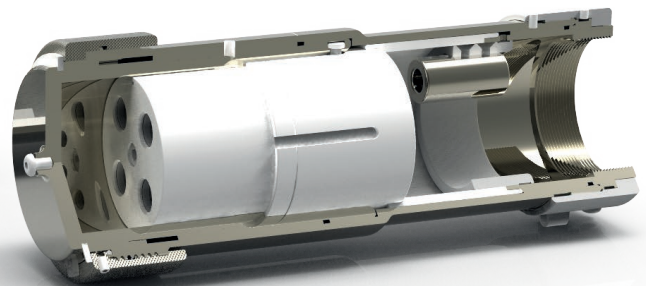

FEATURES



1 Running Coupler

Allows the connector to be installed onto a pre-assembled cable gland.

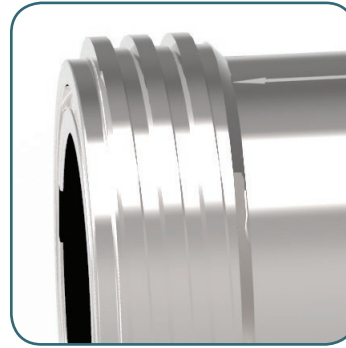

4 Acme Thread at Mating Interface

Unique ACME thread offers a smooth and quick fully mating action.

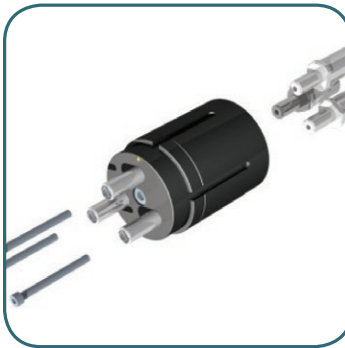

2 Easy Fieldwireable

Insert assembled outside connector shell to assist wiring and allow greater flexibility.

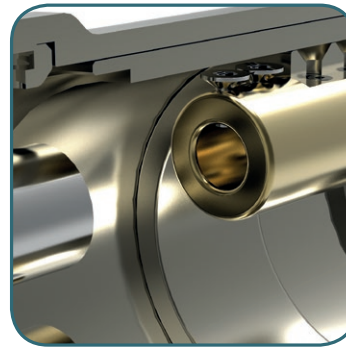

5 Internal Earth

Internal earth fitted as standard. Size to suit cables earthing facility.



3 Keying Position

The unique visual 5 position insert keying system along with the integral machined keyway prevents contact damage and ensures safe use by eliminating the possibility of misconnection of adjacent circuits.

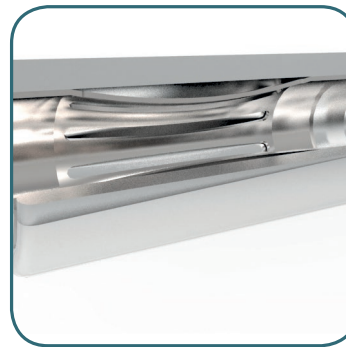

6 Multilam Technology

Tried and tested multiple high contact force, low resistance multilams used in all contacts.

INSERTS

Ex32 - 1 x 50	Ex32 - 1 x 70	Ex32 - 1 x 95	Ex32 - 1 x 120	Ex32 - 1 x 150	Ex40 - 1 x 185	Ex40 - 1 x 240
Ex50 - 3 x 50	Ex50 - 3 x 70	Ex50 - 4 x 50	Ex50 - 4 x 70	Ex50 - 1 x 185	Ex50 - 1 x 240	
Ex63 - 3 x 95	Ex63 - 3 x 120	Ex63 - 3 x 150	Ex63 - 4 x 95			
Ex63 - 4 x 120	Ex63 - 4 x 150	Ex63 - 1 x 300	Ex63 - 1 x 400	Ex75 - 3 x 185		
Ex75 - 3 x 240	Ex75 - 4 x 185	Ex75 - 4 x 240	Ex75 - 1 x 500	Ex75 - 1 x 630		

HAWKE EX SERIES DIMENSIONS (MM)				
CONFIGURATION				
SHELL SIZE 32	SHELL SIZE 40	SHELL SIZE 50	SHELL SIZE 63	SHELL SIZE 75
1 x 50mm ² + Earth	1 x 185mm ² + Earth	3 x 50mm ² + Earth	3 x 95mm ² + Earth	3 x 185mm ² + Earth
1 x 70mm ² + Earth	1 x 240mm ² + Earth	3 x 70mm ² + Earth	3 x 120mm ² + Earth	3 x 240mm ² + Earth
1 x 95mm ² + Earth	–	4 x 50mm ² + Earth	3 x 150mm ² + Earth	4 x 185mm ² + Earth
1 x 120mm ² + Earth	–	4 x 70mm ² + Earth	4 x 95mm ² + Earth	4 x 240mm ² + Earth
1 x 150mm ² + Earth	–	1 x 185mm ² + Earth	4 x 120mm ² + Earth	1 x 500mm ² + Earth
–	–	1 x 240mm ² + Earth	4 x 150mm ² + Earth	1 x 630mm ² + Earth
–	–	–	1 x 300mm ² + Earth	–
–	–	–	1 x 400mm ² + Earth	–

All Hawke Power connectors have a maximum working voltage of (750V AC).
Other voltages and contact configurations also available. contact Hawke International for details.

ORDER CODE

When ordering, select relevant code from each block as shown in the example below:

Power  / Exd-50-S-CR-A-4-50-S-FLFRC-A

POWER 	SELECT CODE	DESCRIPTION		EXAMPLE CODE
PROTECTION	Exd	Flameproof		EXD
SHELL SIZE	32	32		50
	40	40		
	50	50		
	63	63		
	75	75		
MATERIAL	B	Brass <i>Note: (for single core cables, Brass must be used)</i>		S
	S	Stainless Steel (as standard)		
	N	Nickel Plated Brass		
CONNECTOR STYLE	CP	Connector Plug		CR
	CR	Connector Receptacle		
	BR	Bulkhead Receptacle		
INTERNAL EARTH SIZE	A	50mm ²		A
	B	70mm ²		
	C	95mm ²		
	D	120mm ²		
	E	150mm ²		
	F	185mm ²		
	G	240mm ²		
<i>Note: Should be at least 50% of phase conductor size</i>				
NUMBER OF CONTACTS		See Insert Selection Chart		4
CONTACT TYPE		CONTACT TYPE	MAXIMUM CONDUCTOR ACCEPTANCE DIAMETER (MM)	50
	50	50mm ²	9.5	
	70	70mm ²	11.5	
	95	95mm ²	13	
	120	120mm ²	14.5	
	150	150mm ²	16.5	
	185	185mm ²	18.5	
	240	240mm ²	20.5	
	300	300mm ²	25	
	400	400mm ²	29	
	500	500mm ²	32	
	630	630mm ²	38	
	X	No Insert		
INSERT TYPE	P	Pin		S
	S	Socket		
ACCESSORIES	FL	Mounting Flange *		FLFRC
	FPC	Flameproof Plug Cap		
	FRC	Flameproof Receptacle Cap		
	PPC	Environmental Plug Cap		
	PRC	Environmental Receptacle Cap		
<i>* Note: only the connector receptacle (CR) can be flange mounted.</i>				
CERTIFICATION	A	ATEX/IECEX/EAC/INMETRO		A
	N	ATEX/IECEX/EAC/INMETRO /NEC 505 (Voltage reduced to 600V)		
AMBIENT RATING & TEMPERATURE CLASS	1	T5 +40°C Standard		1
	2	T5 +50°C		
	3	T5 +60°C		
	4	T6 +40°C		
	5	T6 +50°C		
	6	T6 +60°C		
<i>T5 +40°C will be supplied as standard if alternative not specified.</i>				

* Order code - see page 63

DIMENSIONS

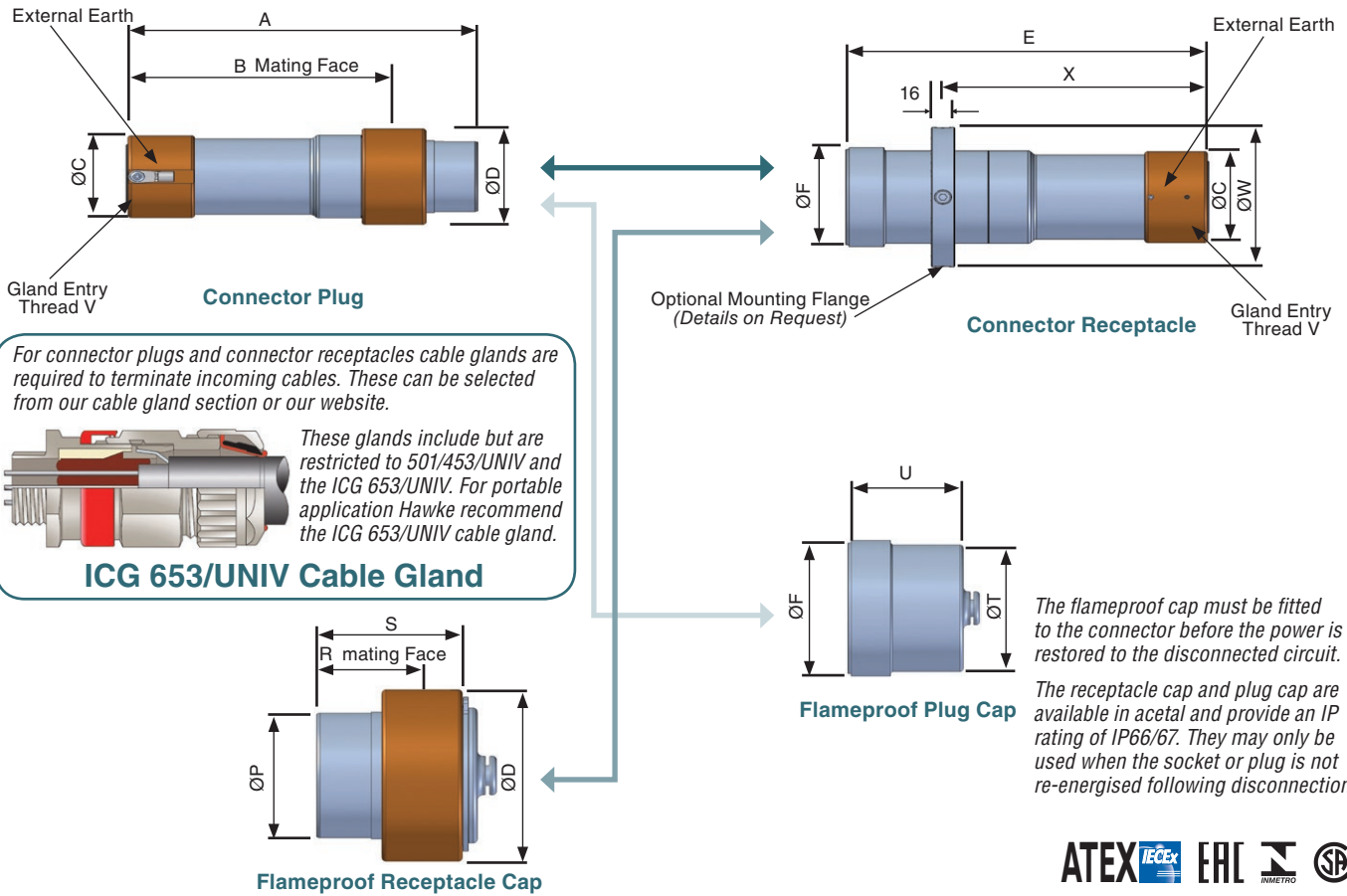

For connector plugs and connector receptacles cable glands are required to terminate incoming cables. These can be selected from our cable gland section or our website.

These glands include but are restricted to 501/453/UNIV and the ICG 653/UNIV. For portable application Hawke recommend the ICG 653/UNIV cable gland.

ICG 653/UNIV Cable Gland



HAWKE EX SERIES DIMENSIONS (MM)					
DIMENSION	EX32P	EX40P	EX50P	EX63P	EX75P
A	228	228	228	228	238
B	168	168	168	168	178
ØC	60	66	76	89	101
ØD	73	79	89	102	114
E	251	251	251	251	261
ØF	67	73	82.5	95	108
ØP	48	55	65	78	90
R	60	60	60	60	60
S	75.5	75.5	75.5	75.5	76
ØT	61	68	77	90	102
U	68.5	68.5	68.5	68.5	68.5
Thread V (1.5mm Pitch)	M32*	M40*	M50*	M63*	M75*
ØW	100	106	116	129	141
X	184	184	184	184	194

*Other entry threads also available.



CALCULATIONS

To select the shell size of the connector, it is essential that you calculate the dissipated wattage of the arrangement. This ensures that the arrangement does not exceed the maximum permitted temperature classification with regard to the upper ambient temperature for the area of installation. (Please refer to Table 1 for the maximum allowable dissipated wattage per connector size).

TABLE 1						
CONNECTOR SIZE	UPPER AMBIENT TEMPERATURE OF +40°C		UPPER AMBIENT TEMPERATURE OF +50°C		UPPER AMBIENT TEMPERATURE OF +60°C	
	TEMPERATURE CLASS		TEMPERATURE CLASS		TEMPERATURE CLASS	
	T6	T5	T6	T5	T6	T5
Ex32P	20.5W	27.5W	15.75W	26W	7.5W	15.75W
Ex40P	22.5W	30.5W	17.5W	28W	8.7W	17.5W
Ex50P	25.8W	35.3W	20W	32.25W	10W	20W
Ex63P	30.2W	41.5W	23.5W	37.7W	11.7W	23.5W
Ex75P	36.3W	49.5W	28.25W	45.25W	14W	28.25W
Maximum allowable dissipated wattage						

Other ambient temperature options can be extrapolated from Table 1 above, or contact Hawke International for more information.

TABLE 2		
CONTACT SIZE	COMBINED CABLE & CONTACT RESISTANCE $\mu(OHMS)$	CONTACT CURRENT RATING
50mm ²	514	190amps
70mm ²	387	240amps
95mm ²	283	290amps
120mm ²	239	340amps
150mm ²	202	385amps
185mm ²	170	440amps
240mm ²	144	520amps
300mm ²	82	590amps
400mm ²	67	670amps
500mm ²	54	720amps
630mm ²	45	780amps

Dissipated wattage calculation

Equation Definitions

- W = Dissipated wattage factor of the connector
- N = The number of conductors to be terminated/number of contacts required. (Note: A contact comprises of a pin and socket).
- I = The current requirement per contact. (Note: This must be equal to or less than the maximum current rating of the contact, as shown in table 2).
- R = The combined cable and contact resistance (see table 2)

Values pertinent to these definitions must then be input into the following equation to calculate the dissipated wattage (w) of your chosen arrangement:

$$W = N \times I^2 \times R$$

(Note: The results must be lower than the maximum figure shown in table 1 for the appropriate temperature class and ambient temperature).

e.g. T6 40°C ambient application with 4 x 95mm² conductors, running at 160 amps.

N = 4 contacts I = 160 amps R = 0.000283Ω (95mm² soldered combined cable and contact resistance)

Therefore W = 4 x 25600 x 0.000283Ω = 28.9 watts.

Therefore, an Ex63P Connector should be specified for this application as the shell size can accommodate the required 4 x 95mm² pin/socket inserts (SEE PAGE 68 - Insert Selection Table) and the resultant dissipated wattage (28.9 watts) is below the maximum permitted 30.2 watts (See Table 1).

This equation can also be transposed to facilitate the calculation of the maximum number of conductors permitted in your selected connector ① and the maximum allowable current within the upper ambient temperature of our location ②.

$$\textcircled{1} \quad N = \frac{W}{R \times I^2} \qquad \textcircled{2} \quad I = \sqrt{\frac{W}{N \times R}}$$

(Note: The result of equation ② must not exceed the maximum current rating of contacts (see Table 2).

Note: Unless otherwise requested, connectors will be marked as T5 with an upper ambient temperature of +40°C.



EXCLUSIVE QUICK WIRING PLUG

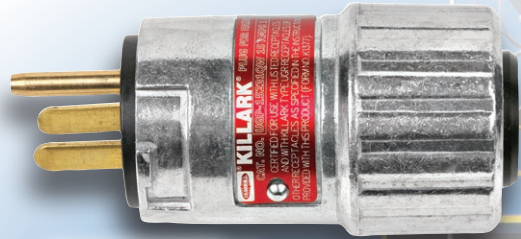

UGPQW Plug

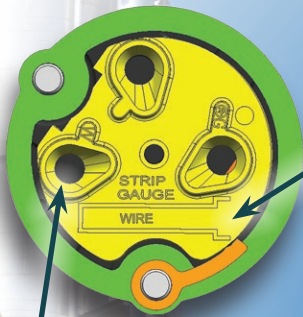

Built-in wire strip gauge

Wire guides enables easy conductor installation

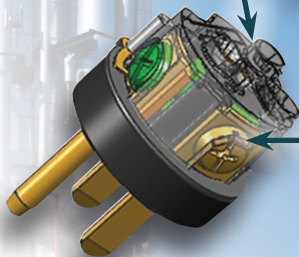

Side tightening terminals use full sized #2 screwdriver (either flat or Phillips)



Old style insulator requires miniature screwdriver

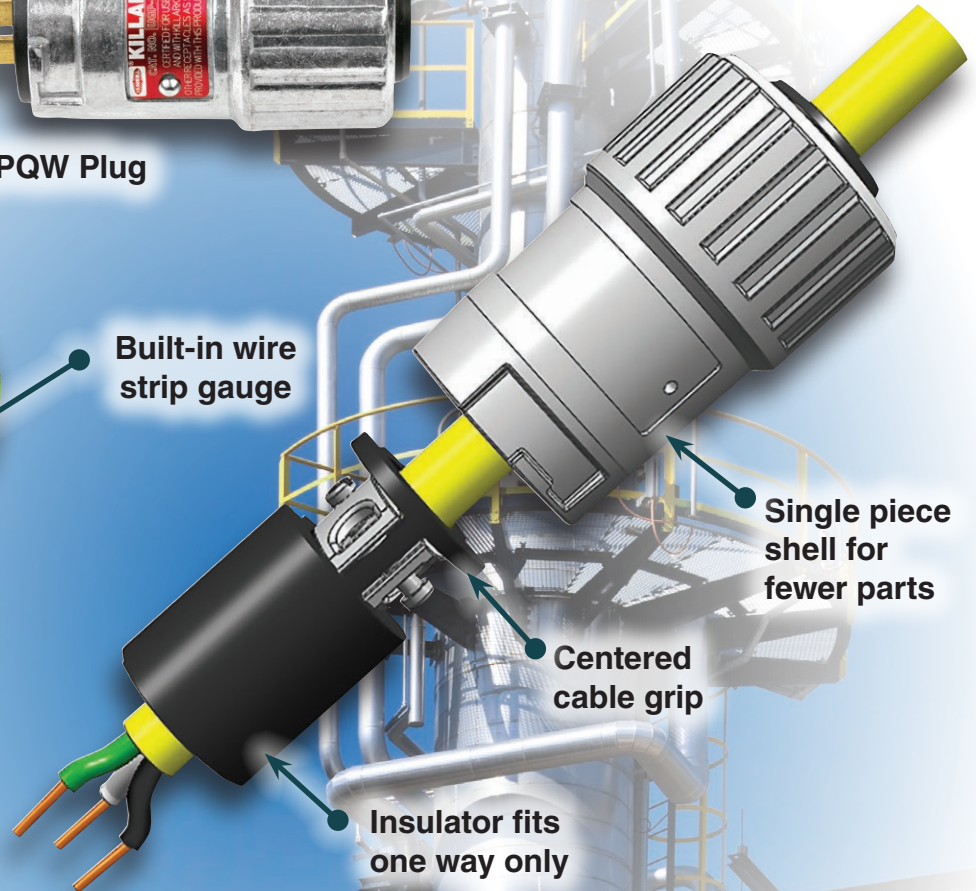

Single piece shell for fewer parts

Centered cable grip

Insulator fits one way only



UGR / UGP BLADED RECEPTACLES



UGR Receptacle



UGPQW Plug



Class I, Div. 1 & 2, Groups B[Ⓢ], C, D
Class I, Zones 1 & 2, Groups IIB+H2, IIA
Class II, Div. 1 & 2, Groups F, G
Class III
NEMA 3, 7 (B, C, D), 9 (F, G)

UL LISTED File No. E91049 and/or E53660

SP Certified File No. LR14667

Wire Size

Suitable for 14-10 guage SOOW or similar cable

FEATURES-SPECIFICATIONS

ACCEPTOR®

The ACCEPTOR® UGP/UGR Plug and Receptacle system, with its unique, patented design, is interchangeable^① with other NEMA bladed type explosion-proof and dust ignition proof devices. The series has been tested and classified for use with Crouse-Hinds® Ark-Gard®2 and Appleton® U-Line® plugs and receptacles in hazardous locations. ^① **Now available in GFCI versions. See pages PR20-PR21**

How The Acceptor System Works

ACCEPTOR receptacles contain an integral switch which must be closed to energize the circuit. The design permits only an approved plug to be energized. To actuate the switch, the plug must be inserted and rotated clockwise approximately 45°. The plug will lock into this position preventing accidental disengagement. To remove, simply push in then turn the plug counterclockwise and pull straight out.

Plugs and receptacles may be used where interchangeable bladed devices are needed in locations made hazardous by the presence of flammable gases or vapors, combustible dusts or easily ignitable fibers and flyings.

Plug can serve to provide power for portable equipment used in both hazardous and non-hazardous areas.

Applications

- Petroleum Refineries, Chemical Plants
- Wet/Damp/Corrosive Areas
- Grain Elevators/Feed Mills

^① Exact models classified for interchangeability are listed in the information sheet provided with the products. Ark-Gard® is a registered trademark of Crouse-Hinds®, U-Line® is a registered trademark of Appleton Electric Company®.

^② Plugs Rated Group B when used with properly rated & installed receptacles.

Features

- All external hardware is 316 stainless steel to provide low maintenance and long life
- Factory sealed chamber in UGR receptacle contains switch's arcing components
- No additional external seals are required, except in Group B applications

Quick Wiring Plug

- Single piece shell for fewer parts
- Transparent wiring entrance holes for easy conductor insertion
- Screws tighten from side with "full sized" screwdriver (slot/Phillips)
- Insulator fits "one way"
- Centered cable grip



- Receptacles are U.L. Listed as raintight. Proper sealing against moisture is assured
- Spring loaded receptacle cover closes when plug is removed to provide protection when not in use
- Copper-free aluminum (less than 4/10 of 1%) alloy resists corrosion
- Electrostatically applied and baked powder epoxy/polyester finish

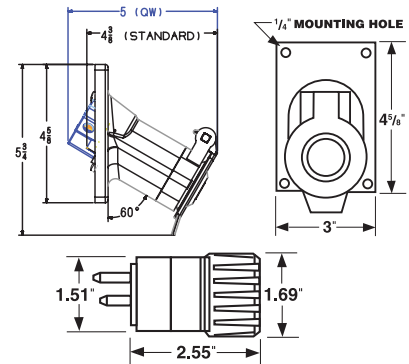

PLUG

ACCEPTOR® plugs conform to NEMA configurations and can be used with standard receptacles in non-hazardous areas to maximize equipment utilization. The system's "turn to engage" feature locks in

plug and can be used to prevent accidental disengagement of critical equipment.

Plugs for use with type S, SO, ST or STO heavy duty cord.

VOLTAGE	NEMA CONFIGURATION	CATALOG NUMBER	NEMA CONFIGURATION	CATALOG NUMBER
		15 AMP PLUG W/QUICK WIRING		20 AMP PLUG W/QUICK WIRING
125VAC	5-15P	UGP-15231QW	5-20P	UGP-20231QW
250VAC	6-15P	UGP-15232QW	6-20P	UGP-20232QW



EXCLUSIVE QUICK WIRING RECEPTACLE

One or two conductors per phase

2nd conductor set feeds next receptacle in circuit

Wire Guides enable easy conductor insertion

Side tightening terminals use full sized #2 screwdriver (either flat or Phillips)

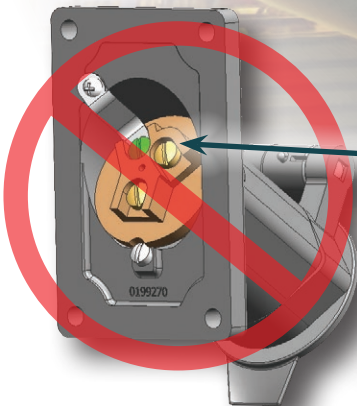
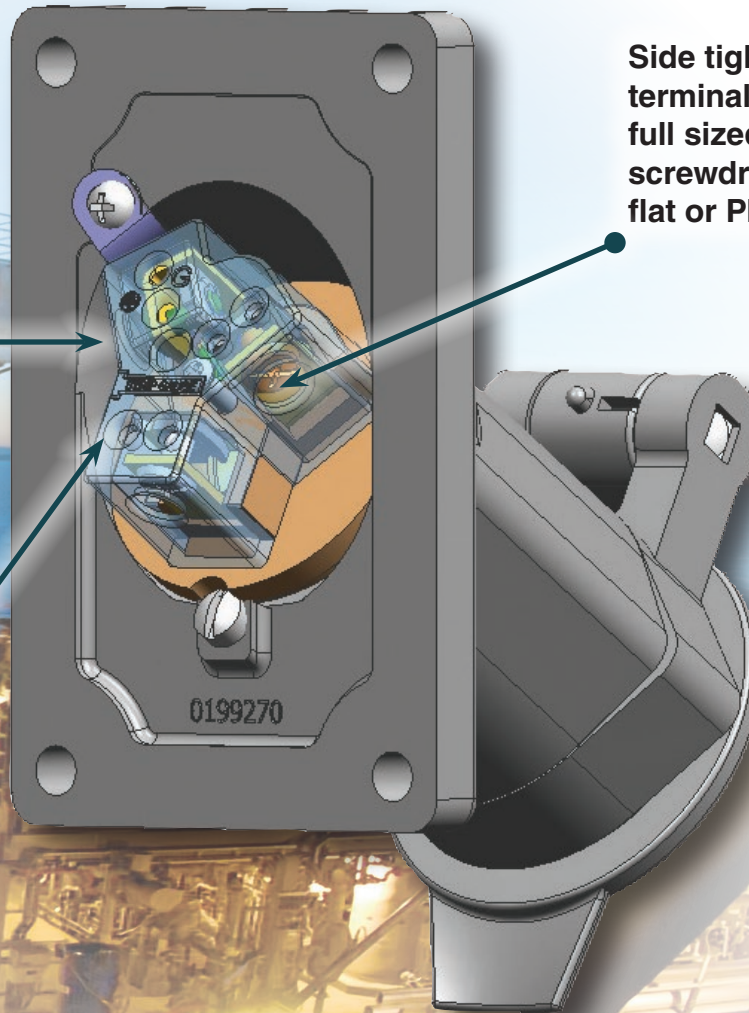

Old Style Terminals

- Recessed – Difficult to attach conductors
- Conductor must be curled – Full engagement uncertain
- Flat Screwdriver only
- Designed for one conductor – required jumper or “double wiring”

CONNECTORS

ACCEPTOR® SERIES



UGRO QUICK WIRING SELECTION INFORMATION



SWB-1, 2, 3



SWB-4, 5, 6



Single Gang

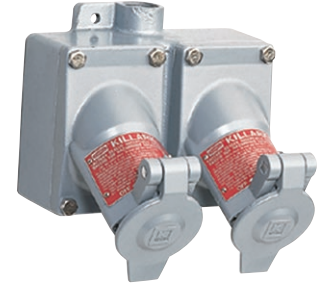

Double Gang

FEATURES-SPECIFICATIONS

RECEPTACLES AND ASSEMBLIES ^④					
NEMA RATING & CONFIGURATION	ENCLOSURE STYLE	HUB SIZE	SINGLE GANG ^{③④} GROUPS C, D, F, & G*	DOUBLE GANG ^{③④} GROUPS C, D, F, & G*	SINGLE GANG ^{①②} GROUPS B, C, D, F & G*
20 Amp 125 Volt 2 POLE 3 WIRE 5-20R	RECEPTACLE ONLY	—	UGR0-20231QW	UGR0-20231QW	—
	DEAD END	1/2"	UGR1-20231QW	UGR7-20231QW	UGRB1-20231QW
		3/4"	UGR2-20231QW	UGR8-20231QW	UGRB2-20231QW
		1"	UGR3-20231QW	UGR9-20231QW	UGRB3-20231QW
	FEED-THRU	1/2"	UGR4-20231QW	UGR10-20231QW	UGRB4-20231QW
		3/4"	UGR5-20231QW	UGR11-20231QW	UGRB5-20231QW
1"		UGR6-20231QW	UGR12-20231QW	UGRB6-20231QW	
15 Amp 125 Volt 2 POLE 3 WIRE 5-15R	RECEPTACLE ONLY	—	UGR0C-15231QW	UGR0C-15231QW	—
	DEAD END	1/2"	UGR1C-15231QW	UGR7C-15231QW	UGRB1C-15231QW
		3/4"	UGR2C-15231QW	UGR8C-15231QW	UGRB2C-15231QW
		1"	UGR3C-15231QW	UGR9C-15231QW	UGRB3C-15231QW
	FEED-THRU	1/2"	UGR4C-15231QW	UGR10C-15231QW	UGRB4C-15231QW
		3/4"	UGR5C-15231QW	UGR11C-15231QW	UGRB5C-15231QW
1"		UGR6C-15231QW	UGR12C-15231QW	UGRB6C-15231QW	
20 Amp 250 Volt 2 POLE 3 WIRE 6-20R	RECEPTACLE ONLY	—	UGR0-20232QW	UGR0-20232QW	—
	DEAD END	1/2"	UGR1-20232QW	UGR7-20232QW	UGRB1-20232QW
		3/4"	UGR2-20232QW	UGR8-20232QW	UGRB2-20232QW
		1"	UGR3-20232QW	UGR9-20232QW	UGRB3-20232QW
	FEED-THRU	1/2"	UGR4-20232QW	UGR10-20232QW	UGRB4-20232QW
		3/4"	UGR5-20232QW	UGR11-20232QW	UGRB5-20232QW
1"		UGR6-20232QW	UGR12-20232QW	UGRB6-20232QW	
15 Amp 250 Volt 2 POLE 3 WIRE 6-15R	RECEPTACLE ONLY	—	UGR0C-15232QW	UGR0C-15232QW	—
	DEAD END	1/2"	UGR1C-15232QW	UGR7C-15232QW	UGRB1C-15232QW
		3/4"	UGR2C-15232QW	UGR8C-15232QW	UGRB2C-15232QW
		1"	UGR3C-15232QW	UGR9C-15232QW	UGRB3C-15232QW
	FEED-THRU	1/2"	UGR4C-15232QW	UGR10C-15232QW	UGRB4C-15232QW
		3/4"	UGR5C-15232QW	UGR11C-15232QW	UGRB5C-15232QW
1"		UGR6C-15232QW	UGR12C-15232QW	UGRB6C-15232QW	

① Items in this column are suitable for Class I, Group B in addition to Class I, Groups C, D. Also suitable for Class I, Zone 1, Groups IIB+H2, IIA.

② Seals must be installed within 6 inches of conduit opening.

③ Items in this column may also be used in Class I, Zone 1, Groups IIB, IIA. Assembly numbers not rated for Group B are shipped as receptacle & back box components.

④ Refer to Killark full-line catalog Section C for additional SWB Series Back Box configurations.

⑤ U.S. and Canadian Codes allow "T" combination slot receptacles to be used with 15A or 20A plugs. Check breaker and wire feed size for proper application ratings.

NOTE: For replacement receptacle cover and hinge, order KIT-173. For dimension see PR15.



ACCEPTOR® SERIES

UGRC CONNECTORS



Connector with Breech-Lock Cap

“3rd Hand” Plug Operation

Class I, Div. 1 & 2, Groups B, C, D^①
 Class I, Zones 1 & 2, Groups IIB+H2, IIA^①
 Class II, Div. 1 & 2, Groups F, G^②
 Class III
 NEMA 3, 4X*

Certified File No. LR14667 ^②
 Certified File No. LR14667 ^①

Wire Size

Suitable for 14-10 guage SOOW or similar cable

FEATURES-SPECIFICATIONS

ACCEPTOR®

CONNECTORS

The ACCEPTOR® UGRC Connector complements UGP/UGR Plugs and Receptacles, as well as Ground Fault Protected UGFI and UGRGF Models.

Used with Acceptor plugs, connectors can extend the reach for hazardous location rated portable equipment such as hand lamps. Connectors eliminate the need for user-created corded box mounted receptacles. UGRC Connectors are interchangeable and classified for use with other NEMA bladed type explosion-proof and dust ignition proof plugs, including Crouse-Hinds® Ark-Gard®2 and Appleton® ULine®.

Features

- Available with the exclusive **Breech-Lock Cap** (see PR5 for more info) – patented notch provides “3rd hand” plug operation (holds lid open while one hand operates plug, and other holds connector).
- Factory Sealed Construction
- Copper-free aluminum (less than 4/10 of 1%) alloy resists corrosion
- Electrostatically applied and baked powder epoxy/polyester finish
- Dead Front Construction with integral switch – requires Hazardous Rated NEMA Bladed plug for operation

Industrial Applications

- Petroleum Refineries
- Chemical/Petrochemical Plants
- Oil Rigs & Platforms
- Wet/Corrosive Environments
- Grain Elevators

Dimensions

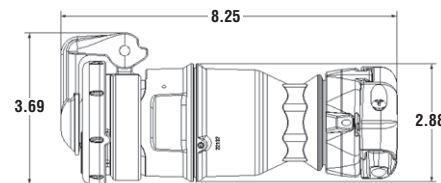

UGRC Connector
 Breech cap model shown, Flip cap model dimensions are similar

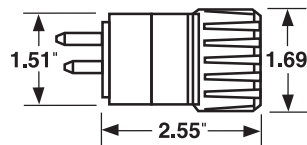

UGP Plug



Connector shown with Acceptor UGRP receptacle mounted in explosion proof Quantum® enclosure



Flip Cap

NEMA CONFIGURATION	125V CONNECTOR CAP STYLE	CATALOG NUMBER	WEATHER RATING
20 AMP 125 VOLT 2 POLE 3 WIRE 5-20R with T-slots ^③	Breech-Lock with Notch Flip Type	UGRC-20231BQW UGRC-20231FQW	N4X* N3**
	Killark 125V Plugs 20 Amp 15 Amp	UGP-20231QW UGP-15231QW	
250V CONNECTOR CAP STYLE			
20 AMP 250 VOLT 2 POLE 3 WIRE 6-20R with T-slots ^③	Breech-Lock with Notch Flip Type	UGRC-20232BQW UGRC-20232FQW	N4X* N3**
	Killark 250V Plugs 20 Amp 15 Amp	UGP-20232QW UGP-15232QW	

* Breech cap models N4X with lid closed and turned, N3 When Plug inserted Hinge Up (see page PR3)

** Flip Lid models N3 with hinge in UP position with or without plug

Replacement Cap and Hinge Kits: Breech KIT-173B, Flip KIT-173

① CSA certified Class I Div.1 for Canada and/or other jurisdictions accepting CSA.

② cCSA_{US} Class II, Groups F & G for US and Canada.

③ U.S. and Canadian Codes allow “T” combination slot receptacles to be used with 15A or 20A plugs. Check breaker and wire feed size for proper application ratings.

Ark-Gard® is a registered trademark of Crouse-Hinds®
 U-Line® is a registered trademark of Appleton Electric Company®

CONNECTORS

ACCEPTOR® SERIES



UGRP PANEL RECEPTACLES



Breach Cap Model



Flip Cap



Typical Installation

Class I, Div. 1 & 2, Groups B, C, D^①
 Class I, Zones 1 & 2, Groups IIB+H2, IIA
 Class II, Div. 1 & 2, Groups F, G
 Class III
 NEMA 3, 4X*

Certified File No. LR14667^②

Wire Size

Suitable for 14-10 gauge SOOW or similar cable

FEATURES-SPECIFICATIONS

ACCEPTOR®

PANEL RECEPTACLES

The ACCEPTOR® UGRP Panel Receptacle complements UGP/UGR Plugs and Receptacles, as well as Ground Fault Protected UGFI and UGRGF Models.

Used with Acceptor plugs, panel receptacles provide local power for hazardous location rated portable equipment such as hand lamps. Units are suitable for Class I Div. 1 or Class I Div.2 depending on the enclosure type used^①.

UGRP Panel Receptacles are interchangeable and classified for use with other NEMA bladed type explosion-proof and dust ignition proof plugs, including Crouse-Hinds® Ark-Gard®2 and Appleton® ULine®.

Features

- Available with the exclusive **Breach-Lock Cap** – patented notch provides “3rd hand” plug operation (holds lid open while one hand operates plug, and other holds connector).
- Factory Sealed Construction
- Copper-free aluminum (less than 4/10 of 1%) alloy resists corrosion
- Electrostatically applied and baked powder epoxy/polyester finish
- Dead Front Construction with integral switch – requires Hazardous Rated NEMA Bladed plug for operation

Ark-Gard® is a registered trademark of Crouse-Hinds®
 U-Line® is a registered trademark of Appleton Electric Company®

Industrial Applications

- Petroleum Refineries
- Chemical/Petrochemical Plants
- Oil Rigs & Platforms
- Wet/Corrosive Environments
- Grain Elevators

- UGRP Receptacles are available “Factory Installed” in the following series:

Enclosures

- » Series EXB, B7E

Distribution Equipment

- » Series D2L, B7L Lighting Panelboards

- Contact factory for ordering information

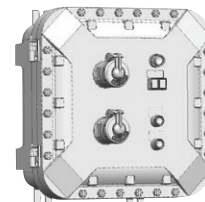

Typical CLI Div. 1 application

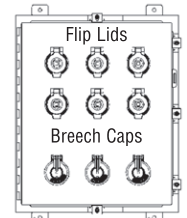

Typical CLI Div. 2 application
 2-3/8” K.O.



Breach Lid



Flip Cap

Dimensions

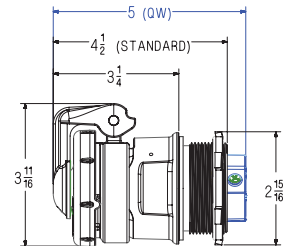

Breach Cap model shown.
 Flip Cap model dimensions are similar

NEMA CONFIGURATION	125V PANEL RECEPTACLE CAP STYLE	CATALOG NUMBER	WEATHER RATING
20 AMP 125 VOLT 2 POLE 3 WIRE 5-20R with T-slots ^③	Breach-Lock with Notch Flip Type	UGRP-20231BQW UGRP-20231FQW	N4X* N3**
	Killark 125V Plugs 20 Amp 15 Amp	UGP-20231QW UGP-15231QW	
20 AMP 250 VOLT 2 POLE 3 WIRE 6-20R with T-slots ^③	Breach-Lock with Notch Flip Type	UGRP-20232BQW UGRP-20232FQW	N4X* N3**
	Killark 250V Plugs 20 Amp 15 Amp	UGP-20232QW UGP-15232QW	

* Breach cap models N4X with lid closed and turned, N3 When Plug inserted Hinge Up

** Flip Lid models N3 with hinge in UP position with or without plug

Replacement Cap and Hinge Kits: Breach KIT-173B, Flip KIT-173

^① Class I Div.1 B, C, D in enclosures certified to 325 explosive PSI (2"-11/16" NPSM threads). Class I Div. 2 in standard location enclosures using only non-arcing components.

^② _{US} CSA Certified for United States, Canada, and other jurisdictions accepting the mark.

^③ U.S. and Canadian Codes allow “T” combination slot receptacles to be used with 15A or 20A plugs. Check breaker and wire feed size for proper application ratings.



ACCEPTOR® SERIES

UGRS / UGRGF RECEPTACLES

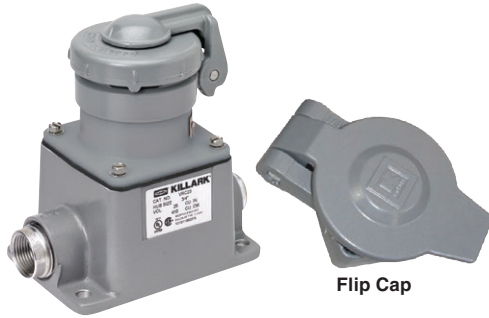

Breach Cap Model

Flip Cap

Class I, Div. 2, Groups B, C, D
Class I, Zone 2, Groups IIB+H2, IIA
Class II, Div. 1 & 2, Groups F, G
Class III
NEMA 3, 4X

Certified File No. LR14667©



UGRGF

Class I, Div. 1 & 2, Groups C, D
Class I, Zones 1 & 2, Groups IIB, IIA
Class II, Div. 1 & 2, Groups F, G
Class III
NEMA 3, 7 (C, D) 9 (F, G)

Certified LR11714
 See files for details or call Killark.

GFI PROTECTED RECEPTACLE

Utilizes FXS GFI and ACCEPTOR® receptacle to interrupt a circuit, when a ground fault is detected on equipment which may be handled by personnel in hazardous locations.

Features

- Factory Sealed
- Test and Reset push buttons are provided on cover assembly, with optional pilot light available. Unit should be tested monthly
- Includes new GFCI to meet latest UL943 GFCI standards revisions
- Exterior gasket provides NEMA 3 weatherproof protection
- Ground boss for grounding in the splice box
- Color coded wiring and stainless steel cover bolts
- Receptacle used is UGR0-20231QW.

NEMA RATING & CONFIGURATION	ENCLOSURE STYLE	HUB SIZE	CATALOG NUMBER
20A, 125V, 2P, 3W	Dead End	1/2"	UGRGF107
	Dead End	3/4"	UGRGF108
	Dead End	1"	UGRGF109
	Feed Thru	1/2"	UGRGF110
	Feed Thru	3/4"	UGRGF111
	Feed Thru	1"	UGRGF112

Electrical Rating

GFI units are rated at 20A, 120 VAC, 60Hz. Class A.

4-6 milliamp trip setting

Trip Time-UL Curve

© For Red LED pilot light indicator of live circuit, add "-PL" to catalog number. Example - UGRGF107-PL.

FEATURES-SPECIFICATIONS

ACCEPTOR®

SQUARE RECEPTACLE

UGRS Receptacles utilize VERSAMATE® 30A mounting boxes and are designed to provide "ROTATABLE" design enables cover hinge location to be in most convenient position for application. May also be utilized with sheet metal enclosures which contain no arcing devices.

Dimensions

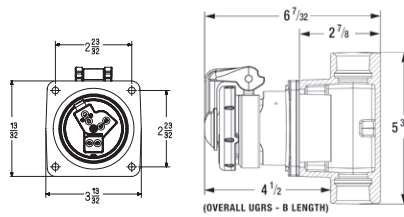

UGRS RECEPTACLE MTG DIMENSIONS

UGRS - B ON VRC BOX

Breach Cap model shown.
 Flip Cap model dimensions are similar

NEMA CONFIGURATION	125V SQUARE RECEPTACLE CAP STYLE	CATALOG NUMBER
20 AMP 125 VOLT 2 POLE 3 WIRE 5-20R with T-slots	Breach-Lock with Notch* Flip Lid Type**	UGRS-20231BQW UGRS-20231FQW
	Killark 125V Plugs*** 20 Amp 15 Amp	UGP-20231QW UGP-15231QW
250V SQUARE RECEPTACLE CAP STYLE		
20 AMP 250 VOLT 2 POLE 3 WIRE 6-20R with T-slots	Breach-Lock with Notch* Flip Lid Type**	UGRS-20232BQW UGRS-20232FQW
	Killark 250V Plugs 20 Amp 15 Amp	UGP-20232QW UGP-15232QW

* Breach cap models N4X with lid closed and turned, N3 When Plug inserted Hinge Up

** Flip Lid models N3 with hinge in UP position with or without plug

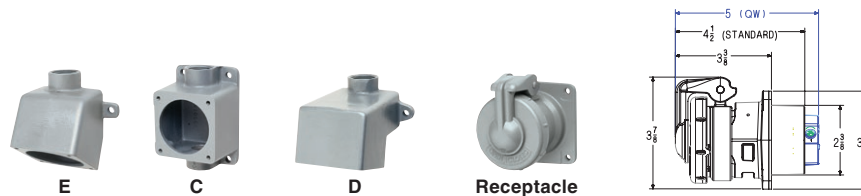

UGRS RECEPTACLE & BACKBOXES ①				
	E TYPE DEAD END ②	C TYPE FEED THRU ②	D TYPE ANGLED FEED THRU ②	RECEPTACLE ONLY
20A 125V	UGRS-20231BE2QW	UGRS-20231BC2QW	UGRS-20231BD2QW	UGRS-20231BQW
20A 250V	UGRS-20232BE3QW	UGRS-20232BC3QW	UGRS-20232BD3QW	UGRS-20232BQW

① Receptacles listed are with Breach cap; for Flip Cover change B to F.

② Boxes listed are for 3/4"; for 1/2" change last digit to 1, for 1" change last digit to 3.

③ cSA_{US} Certified for United States, Canada, and other jurisdictions accepting the mark.

④ U.S. and Canadian Codes allow "T" combination slot receptacles to be used with 15A or 20A plugs. Check breaker and wire feed size for proper application ratings.



UGFI GROUND FAULT PROTECTOR

ACCEPTOR®



Adapter Unit

The GFCI protected ACCEPTOR® is the solution to OSHA's requirements for GFCI protection when using portable equipment in hazardous and wet locations. For use with 125V, or 125/250V^③ 15 or 20 amp receptacles without GFCI protection, the **Adapter Unit** provides GFCI and circuit protection to connected apparatus by simply being plugged into an existing receptacle.

The **Hard-Wired Unit** provides the same protection and is used directly as a GFCI protected device. Units are feed-through with one close-up plug.

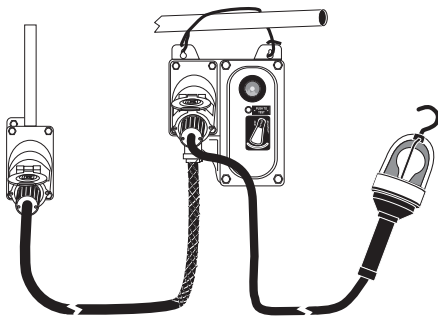

Typical Application with XHL Series Hand Lamp

UL LISTED File No. E91049^②

CSA US Certified File No. LR14667^②

FEATURES-SPECIFICATIONS

Adapter Unit

- No need to permanently alter existing installations; **Portable Unit** can be temporarily hung using included strap near an existing receptacle wherever protection is required
- Factory Sealed Unit
- Acceptor® plug and cord set included with **Adapter Unit**. Cord is 36"

Hard-Wired Unit

- provides GFCI and circuit protection in new installations, or as an upgrade or replacement for non-GFCI receptacles
- Factory Sealed, except Group B

Adapter and Hard-Wired Unit

- GFCI device also provides circuit protection, for connected apparatus, against current overload and short circuits
- Acceptor® receptacles and plugs are interchangeable with both Crouse-Hinds® Ark-Gard®^② and Appleton® U-Line® products
- Amber pilot light provides indication that the receptacle is energized.
- Units can be Padlocked OFF for maintained safety
- Fully gasketed GFCI compartment prevents moisture from damaging electronic components
- Same high quality materials as the standard ACCEPTOR®

- ① Hard-Wired assemblies in Group B areas require sealing within 6" of enclosure.
- ② 125VAC & 250 VAC devices are CCSAUS certified; 125VAC devices are also UL Listed.
- ③ 2P 250V units are for 2 "hot line" applications and include 2P 5mA GFI breakers. 2P Units are for 120/240V or 120/208Y Grounded Power Supply Systems ONLY. **Do NOT use with Delta supply systems.**

Ark-Gard® is a registered trademark of Crouse-Hinds®
U-Line® is a registered trademark of Appleton Electric Company®.

- **Adapter Unit**
Class I, Div. 2, Groups B, C, D
Class I, Zone 2, Groups IIB+H2, IIA
Class II, Div. 1 & 2, Groups F, G
Class III, Div. 1 & 2
- **Hard-Wired Unit**
Class I, Div. 1 & 2, Groups B, C, D
Class I, Zones 1 & 2, Groups IIB+ H2, IIA
Class II, Div. 1 & 2, Groups F, G
Class III, Div. 1 & 2

NEMA 3 ENCLOSURE TYPE
(Adapter or Hard-Wired units)

GFCI RECEPTACLE ADAPTER (W/CORD SET)

20A 125V ②	UGFI20AD	 5-20R
15A 125V ②	UGFI15AD	 5-15R
20A 250V ②③	UGFI202AD	 6-20R
15A 250V ②③	UGFI152AD	 6-15R

HARD WIRED (PERMANENTLY MOUNTED) GFCI RECEPTACLE

20A 125V ②	 5-20R	1/2" HUB 3/4" HUB 1" HUB	UGFI20C1 UGFI20C2 UGFI20C3
15A 125V ②	 5-15R	1/2" HUB 3/4" HUB 1" HUB	UGFI15C1 UGFI15C2 UGFI15C3
20A 250V ②③	 6-20R	1/2" HUB 3/4" HUB 1" HUB	UGFI202C1 UGFI202C2 UGFI202C3
15A 250V ②③	 6-15R	1/2" HUB 3/4" HUB 1" HUB	UGFI152C1 UGFI152C2 UGFI152C3

Hard-Wired Unit

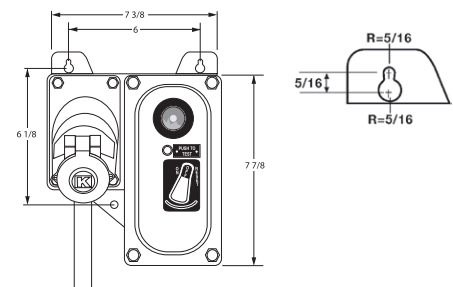



VERSAMATE® SERIES

VSQ SWITCHED RECEPTACLES

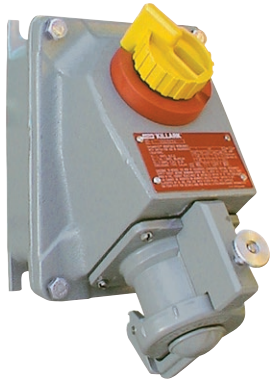

Plug

- VSQ Hazardous Location Ratings
Class I, Div. 1 & 2, Groups B, C, D
Class I, Zones I & 2, Groups IIB+H2, IIA
Class II, Div. 1 & 2, Groups F & G
Class III
NEMA 3, 4, 4X, 7 (B, C, D), 9 (F, G)
- VWSQ for Wet & Corrosive Locations
NEMA 3, 4, 4X

Wire Range

30 Amp Regular Stranding Max #10
60 Amp Regular Stranding Max #4

VSQ File No. LR14667

VWSQ File No. E216488

FEATURES-SPECIFICATIONS

Features

- N4X with receptacle lid turned shut or with plug locking ring tightened
- Copper-free aluminum construction with electrostatically applied polyester/epoxy finish. Handle mechanism is chemical resistant Valox® (TM General Electric).
- Compact size and footprint
- Plug Interlock Mechanism for Dead-front construction. Switch cannot be turned "ON" without fully inserted plug. Plug cannot be removed with switch in "ON" position
- Plug held in place when switch is "Off" for convenience. Pull operated release mechanism. Plug and wiring do not have to be twisted or held to operate switch
- Factory Wired Receptacle; easy to wire line side of switch
- Easily visible "On-Off" indicator handle
- "Off" position is padlockable for maintenance safety
- Auxiliary Contact (late-make early-break) contact rated 10 Amp, 1/3 HP at 125/250 VAC. Can be used for operating pilot lights or starter coils (standard model only)

- Feed-through construction
- Horsepower Rated
- Internal switch horsepower rated as "motor disconnect"

HORSEPOWER RATINGS (VAC)①		120	240	480	600
30A	1Ø	2	5	10	15
	3Ø	3	7.5	15	20
60A	1Ø	–	10	15	20
	3Ø	–	10	25	30

VSQ & VWSQ RECEPTACLES					
AMPS	CIRCUIT	CATALOG NUMBER			
		VSQ HAZARDOUS	VWSQ N4X ONLY	PLUG ORIG.	PLUG AT
30	2W3P	VSQ3023	VWSQ3023	VP3385	VP3023
	3W4P	VSQ3034	VWSQ3034	VP3485	VP3034
60	2W3P	VSQ6023	VWSQ6023	VP6385	VP6023
	3W4P	VSQ6034	VWSQ6034	VP6485	VP6034

NOTES: VSQ/VWSQ 30 Amp models come standard with 1" drilled and tapped conduit openings top and bottom plus two 1" x 3/4" reducers and one 3/4" close-up plug for maximum flexibility. 60 amp models come with 1-1/2" openings top and bottom and one 1-1/2" close-up plug.

VSQ & VWSQ Receptacle covers are NOT interchangeable.

① Refers to internal switch only.

Dimensions

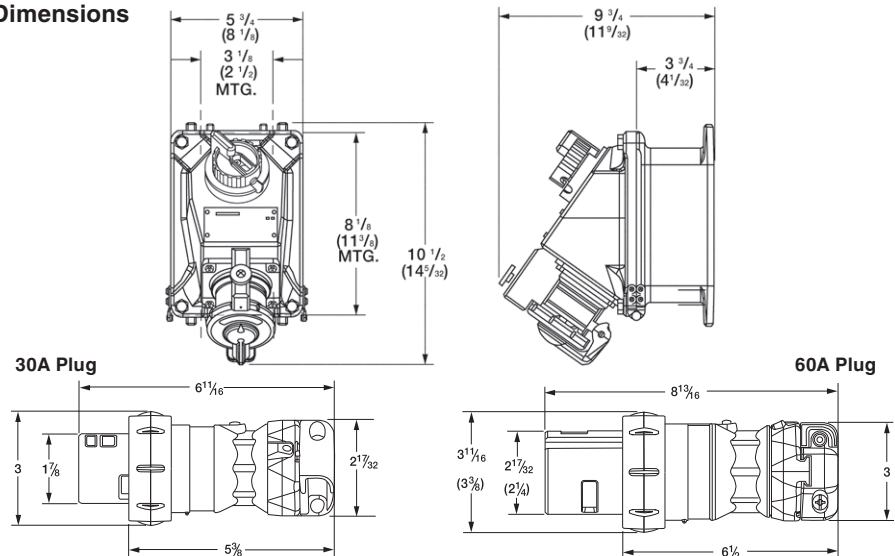

Dimensions shown are in inches for 30 AMP; 60 Amp dimensions in ().

NOTES: 60A devices have adjustable ductile lugs (vertical or side) for attachment to uneven surfaces. Ordinary twist type wire connectors are used for final connections on 30A. 60A devices have terminal blocks.

MODIFICATIONS*	
CATALOG NUMBER	DESCRIPTION
S37	Polarization for receptacles, plugs

* See page PR3 for more information on this option

VersaMate VSQ & VWSQ Receptacles use VersaMate Style II plugs and are compatible with appropriately configured Crouse-Hinds® Arkrite® or Appleton® Powertite® plugs (when installed in accordance with instructions furnished with device)

Arkrite® is a registered trademark of Crouse-Hinds®. Powertite® is a registered trademark of Appleton®.

CONNECTORS

VERSAMATE® SERIES



VSQ-FS FACTORY SEALED

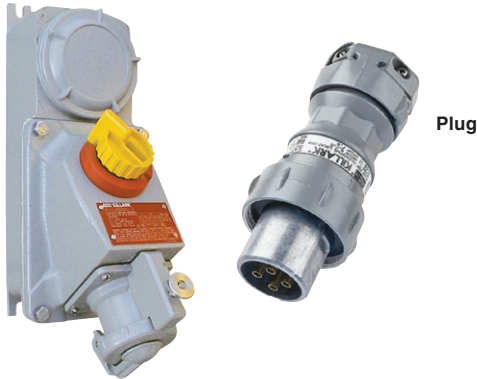

Class I, Div. 1 & 2, Groups B, C, D
 Class I, Zones 1 & 2, Groups IIB+H2, IIA
 Class II, Div. 1 & 2, Groups F & G
 Class III
 NEMA 3, 4, 4X, 7 (B, C, D), 9 (F, G)

Certified File No. LR14667

Wire Range

30 Amp Regular Stranding Max #10
 60 Amp Regular Stranding Max #4

FEATURES-SPECIFICATIONS

Features – same as VSQ ① plus:

- Factory Sealed Construction eliminates need for conduit sealing at the device
- Saves Installation Time & Labor – facilitates rework
- Switch has factory wired line and load terminals. Load terminals feed sealed receptacle as in a standard VSQ. Line wiring is passed from the sealed compartment into the **wiring chamber**
- Receptacles may be loosened from back box and turned 180 degrees to adjust for top or bottom feed.
- Ordinary twist type wire connectors are used for final connections on 30A. 60A devices have terminal blocks

VSQ - FS RECEPTACLES

AMPS	CIRCUIT	CATALOG NUMBER		
		VSQ-FS HAZARDOUS	PLUG ORIG.	PLUG AT
30	2W3P	VSQ3023FS	VP3385	VP3023
30	3W4P	VSQ3034FS	VP3485	VP3034
60	2W3P	VSQ6023FS	VP6385	VP6023
60	3W4P	VSQ6034FS	VP6485	VP6034

MODIFICATIONS*

CATALOG NUMBER	DESCRIPTION
S37	Polarization for receptacles & plugs

NOTES: VSQ-FS 30 Amp models come standard with one 1" drilled and tapped conduit openings into the wiring chamber plus one 1" x 3/4" reducer.
 VSQ-FS 60 Amp models come standard with one 1-1/2" drilled and tapped conduit openings into the wiring chamber plus one 1-1/2" x 1-1/4" reducer.

* See page PR3 for more information on this option.

① VSQ-FS models do not have auxiliary contacts.

Dimensions

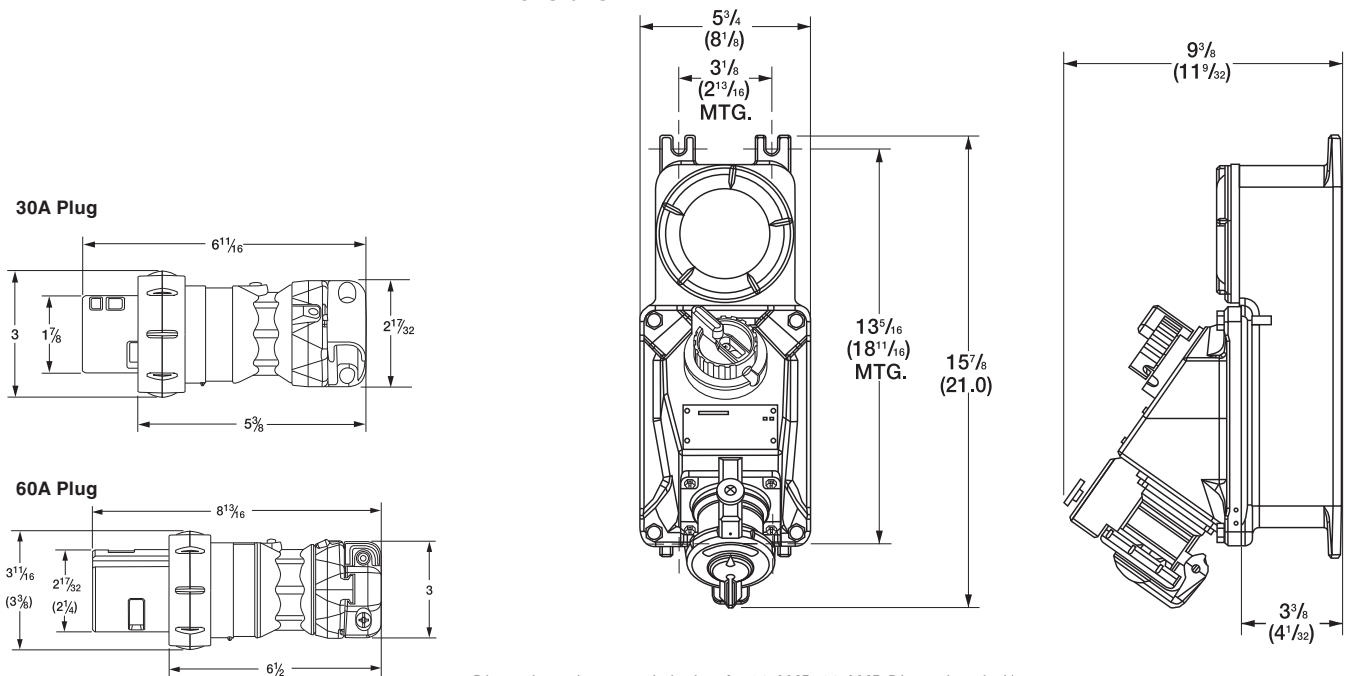

Dimensions shown are in inches for 30 AMP. 60 AMP Dimensions in ().



VERSAMATE® SERIES

VBQ BREAKER PROTECTED

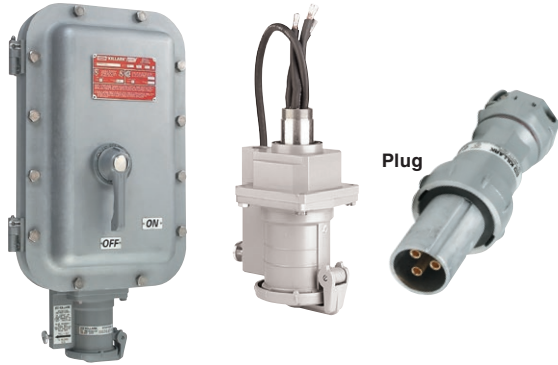

Receptacle assembly is field replaceable for maintenance.

Ordering information listed in the instruction sheets provided with the product.

Class I, Div. 1 & 2, Groups B, C, D
Class I, Zones I & 2, Groups IIB+H2, IIA
Class II, Div. 1 & 2, Groups F & G
Class III
NEMA 3, 4, 4X, 7 (B, C, D), 9 (F, G)



FEATURES-SPECIFICATIONS

Features

Receptacle:

- N4X with receptacle lid turned shut or with plug locking ring tightened
- Plug held in place when switch is "Off" for convenience. Pull button operated release mechanism. Plug does not have to be twisted to operate switch
- Dead-front construction when receptacle is off. Switch cannot be turned "ON" without fully inserted plug. Plug cannot be removed with switch in "ON" position
- Wire Connections do not bend when opening and closing door – minimizes loosening during installation or maintenance procedures
- For ground fault option, contact factory

VersaMate VBQ Receptacles use VersaMate Style II plugs found on 30, 60 and 100 amp pages and are compatible with appropriately configured Crouse-Hinds® Arkrite® or Appleton® Powertite® plugs (when installed in accordance with instructions furnished with device). Arkrite® is a registered trademark of Crouse-Hinds®. Powertite® is a registered trademark of Appleton®.

Replacement Parts:

- Enclosure gasket VBQ-535
- External circuit breaker handle kit CBHK-100H

See instruction sheet included with device for other available replacement parts.

Enclosure:

- Spacious wiring room. Meets the latest NEC wire bending requirements for circuit breaker enclosures
- Ductile Mounting Lugs to adjust to uneven surfaces
- Copper-free construction with 316 grade Stainless Steel External Hardware
- Quick Release Cover Bolts with Triple Leads – only 3-1/2 turns to disengage

- Recessed Flange Notches – Allows easier cover opening with prying instrument without flange damage
- Electrostatically applied polyester/epoxy finish
- Visible "ON" external Breaker Handle has provisions for locking "ON" or "OFF" with up to three Padlocks
- Internal Lock-Off provision for maintenance when no hazardous materials are present

Dimensions

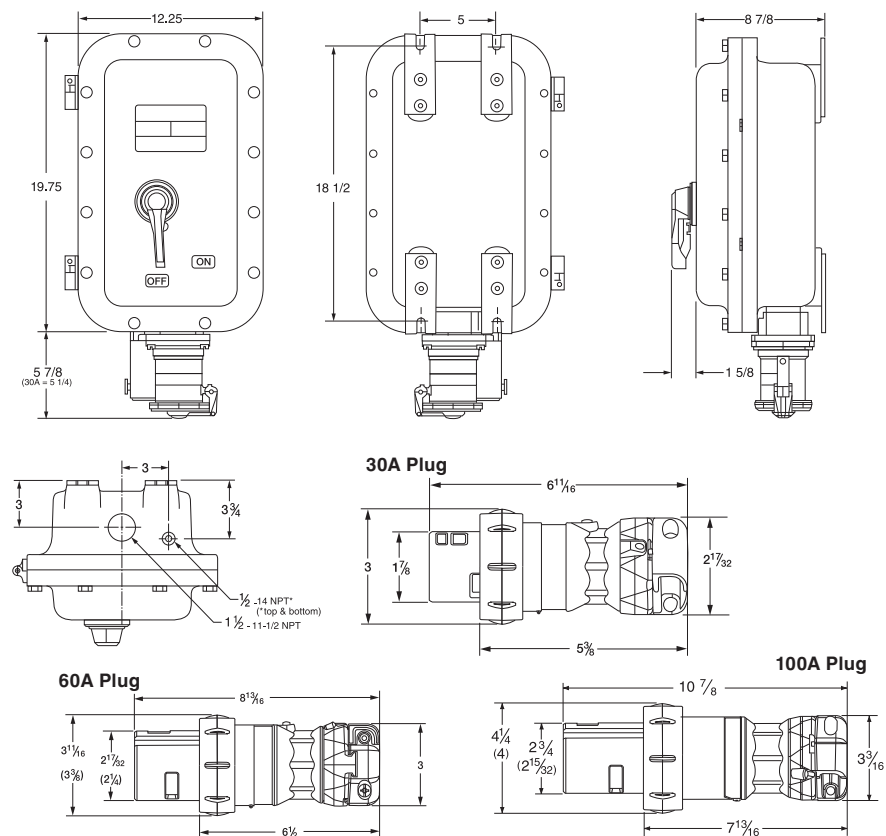

CONNECTORS

VERSAMATE® SERIES



VBQ BREAKER PROTECTED



Internal Lock-Off provision for maintenance when no hazardous materials are present

Class I, Div. 1 & 2, Groups B, C, D
 Class I, Zones I & 2, Groups IIB+H2, IIA
 Class II, Div. 1 & 2, Groups F & G
 Class III
 NEMA 3, 4, 4X, 7 (B, C, D), 9 (F, G)

UL cUL File No. E184637

FEATURES-SPECIFICATIONS

VBQ RECEPTACLES									
RECEPTACLE	CIRCUIT	BREAKER	CATALOG NUMBER						
			SQUARE D HDL SERIES	SQUARE D HGL SERIES	CUTLER-HAMMER EHD SERIES	CUTLER-HAMMER FD SERIES	PLUG		
							ORIG.	AT	
30	2W3P	20	VBQ3023SN20	VBQ3023SH20	VBQ3023CN20	VBQ3023CH20	VP3385	VP3023	
		30	VBQ3023SN30	VBQ3023SH30	VBQ3023CN30	VBQ3023CH30			
		40	VBQ3023SN40	VBQ3023SH40	VBQ3023CN40	VBQ3023CH40			
		50	VBQ3023SN50	VBQ3023SH50	VBQ3023CN50	VBQ3023CH50			
	3W4P	20	VBQ3034SN20	VBQ3034SH20	VBQ3034CN20	VBQ3034CH20	VP3485	VP3034	
		30	VBQ3034SN30	VBQ3034SH30	VBQ3034CN30	VBQ3034CH30			
		40	VBQ3034SN40	VBQ3034SH40	VBQ3034CN40	VBQ3034CH40			
		50	VBQ3034SN50	VBQ3034SH50	VBQ3034CN50	VBQ3034CH50			
60	2W3P	50	VBQ6023SN50	VBQ6023SH50	VBQ6023CN50	VBQ6023CH50	VP6385	VP6023	
		60	VBQ6023SN60	VBQ6023SH60	VBQ6023CN60	VBQ6023CH60			
		70	VBQ6023SN70	VBQ6023SH70	VBQ6023CN70	VBQ6023CH70			
		90	VBQ6023SN90	VBQ6023SH90	VBQ6023CN90	VBQ6023CH90			
	3W4P	50	VBQ6034SN50	VBQ6034SH50	VBQ6034CN50	VBQ6034CH50	VP6485	VP6034	
		60	VBQ6034SN60	VBQ6034SH60	VBQ6034CN60	VBQ6034CH60			
		70	VBQ6034SN70	VBQ6034SH70	VBQ6034CN70	VBQ6034CH70			
		90	VBQ6034SN90	VBQ6034SH90	VBQ6034CN90	VBQ6034CH90			
	100	2W3P	50	VBQ1023SN50	VBQ1023SH50	VBQ1023CN50	VBQ1023CH50	VP10387	VP1023
			70	VBQ1023SN70	VBQ1023SH70	VBQ1023CN70	VBQ1023CH70		
			90	VBQ1023SN90	VBQ1023SH90	VBQ1023CN90	VBQ1023CH90		
			100	VBQ1023SN100	VBQ1023SH100	VBQ1023CN100	VBQ1023CH100		
3W4P		50	VBQ1034SN50	VBQ1034SH50	VBQ1034CN50	VBQ1034CH50	VP10487	VP1034	
		70	VBQ1034SN70	VBQ1034SH70	VBQ1034CN70	VBQ1034CH70			
		90	VBQ1034SN90	VBQ1034SH90	VBQ1034CN90	VBQ1034CH90			
		100	VBQ1034SN100	VBQ1034SH100	VBQ1034CN100	VBQ1034CH100			

CIRCUIT BREAKER INTERRUPTING RATINGS	208/240 VAC	480 VAC	600 VAC	250 VDC†
Square D HDL	25,000	18,000	14,000	20,000
Square D HGL	65,000	35,000	18,000	20,000
Cutler-Hammer EHD	18,000	14,000	—	10,000
Cutler-Hammer FD	65,000	25,000	18,000	10,000

Consult Breaker Manufacturer literature for Horsepower Ratings.

† DC ratings apply to substantially non-inductive circuits.

CIRCUIT BREAKER	WIRE RANGE
Square D	To 30 Amp #14-4 cu.; 35-100 Amp #14-1/0 cu.
Cutler-Hammer	To 20 Amp #14-10 cu.; 30-100 Amp #14-1/0 cu.

MODIFICATIONS ^①	
CATALOG NUMBER	DESCRIPTION
S37	Polarization for receptacles & plugs
SU10	Drain
SU11	Breather
SU3	Drain and Breather (CSA Groups C & D)

① See page PR3 and price sheet for more information on these options.

Contact factory for VBQ with ground fault option



VERSAMATE® SERIES

VSI NON-METALLIC PLUGS AND SWITCHED RECEPTACLES



Class I, Div. 2, Groups A, B, C, D
 Class I, Zones 1 & 2, Groups IIC, IIB, IIA
 AEx de IIC T6
 Class II, Div. 1 & 2, Groups E, F, G
 Class III
 NEMA 3, 4, 4X, IP66



File 3014299



Certified - File LR240743

See files for details or call Killark

FEATURES-SPECIFICATIONS



Applications

- For use in hazardous and corrosive environments such as refineries, chemical plants, water treatment and bio gas plants, and wherever a combustible gas-air mixture or combustible dust may occur

Features

- Color coding and pin configuration makes it physically impossible to mate plugs and receptacles of different voltages and current ratings
- Interlocked switch mechanism prevents accidental removal of plug from receptacle under load
- Horsepower rated disconnect switch
- Dust caps* included with 20A and 30A plugs as standard

- No seal required within Class I, Division 2 applications.
- Provision for up to two optional auxiliary contact blocks, useful for signaling circuits or starter coils.③
- Dimensional information – page PR28.

PARTS AND ACCESSORIES③	PART NUMBER
Auxiliary Contact Block NC, A600④	VSIAUXNC
Auxiliary Contact Block NO, A600④	VSIAUXNO

④ 10A rating for one auxiliary block; 5A if two are used.
 Position noted (NC or NO) is when main switch is off.

VSI SERIES PLUGS & SWITCHED RECEPTACLES					
DESCRIPTION		CATALOG NUMBER			
	AC VOLTAGE AND COLOR CODE	20 AMP①		30 AMP②	
		RECEPTACLE	PLUG	RECEPTACLE	PLUG
2 Pole 3 Wire	125 Yellow	VSI20R304	VSI20P304	—	—
	250 Blue	VSI20R306	VSI20P306	—	—
	480 Red	VSI20R307	VSI20P307	—	—
3 Pole 4 Wire	3 Ø 250 Blue	VSI20R409	VSI20P409	VSI30R409	VSI30P409
	3 Ø 480 Red	VSI20R407	VSI20P407	VSI30R407	VSI30P407
	3 Ø 600 Black	VSI20R405	VSI20P405	VSI30R405	VSI30P405
4 Pole 5 Wire	3 ØY 120/208 Blue	VSI20R509	VSI20P509	VSI30R509	VSI30P509
	3 ØY 277/480 Red	VSI20R507	VSI20P507	VSI30R507	VSI30P507
	3 ØY 347/600 Black	VSI20R505	VSI20P505	VSI30R505	VSI30P505

① VSI 20A devices are compatible with prior 16A models. However, the rating of the lower amperage will apply.

② VSI 30A devices are compatible with prior 32A models. Ratings of the lower amperage will apply.

* Dust caps shall be installed on plugs with receptacle cover closed when the plug is not engaged in the receptacle.

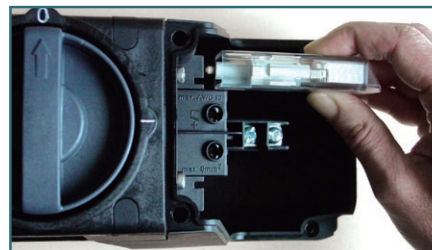

Snap into side(s) of terminal block

TECHNICAL DATA				
RECEPTACLE		20 AMP		30 AMP
ENCLOSURE MATERIAL		POLYAMIDE		
AMBIENT TEMPERATURE, T _a		-30°C (-22°F) to +55°C (131°F)		
TERMINAL CAPACITY		2 wires, rated 75°C (Ta<45°C) or 90°C (Ta>45°C)		
		16-10 AWG		14-8 AWG
SWITCH RATING	(Horsepower)	1-phase	3-phase	3-phase
	120 VAC	1.5 HP	—	—
	240 VAC	3 HP	5 HP	10 HP
	480 VAC	5 HP	10 HP	20 HP
	600 VAC	—	15 HP	25 HP
LINE SUPPLY FUSE		CLASS J - size per NEC/CEC requirement, upstream ahead of unit		
BOTTOM ENTRY		3/4" NPT		1" NPT

TECHNICAL DATA		
PLUG	20 AMP	30 AMP
ENCLOSURE MATERIAL	POLYAMIDE	
TERMINAL CAPACITY	1 wire, rated 75°C (Ta<45°C) or 90°C (Ta>45°C)	
	16-10 AWG	14-8 AWG
CORD OUTER DIA.	0.3" - 0.8"	0.6" - 1.1"

CONNECTORS

VERSAMATE® SERIES



VSI NON-METALLIC PLUGS AND SWITCHED RECEPTACLES



Class I, Div. 2, Groups A, B, C, D
Class I, Zones 1 & 2, Groups IIC, IIB, IIA
AEx de IIC T6
Class II, Div. 1 & 2, Groups E, F, G
Class III
NEMA 3, 4, 4X, IP66

File 3014299

Certified - File LR240743
 See files for details or call Killark

FEATURES-SPECIFICATIONS



Applications

- For use in hazardous and corrosive environments such as refineries, chemical plants, water treatment and bio gas plants, and wherever a combustible gas-air mixture or combustible dust may occur

- When VSI Series is installed in Class II Div. 1 & 2 locations, dust caps for plugs are required. See ordering information below

Features

- Color coding and pin configuration makes it physically impossible to mate plugs and receptacles of different voltages and current ratings
- No seals required within Class I, Div. 2 applications

- Interlocked switch mechanism prevents accidental removal of plug from receptacle under load
- Horsepower rated disconnect switch includes 1 auxiliary contact (late make, early break) for signaling circuits.
- 63A, 125A models

Dimensional Information

- See page PR28

VSI SERIES PLUGS & SWITCHED RECEPTACLES					
DESCRIPTION		CATALOG NUMBER			
	AC VOLTAGE AND COLOR CODE	63 AMP		125 AMP	
		RECEPTACLE	PLUG	RECEPTACLE	PLUG
3 Pole 4 Wire	3 Ø 250 Blue	VSI63R409	VSI63P409	VSI125R409	VSI125P409
	3 Ø 480 Red	VSI63R407	VSI63P407	VSI125R407	VSI125P407
	3 Ø 600 Black	VSI63R405	VSI63P405	VSI125R405	VSI125P405
4 Pole 5 Wire	3 ØY 120/208 Blue	VSI63R509	VSI63P509	VSI125R509	VSI125P509
	3 ØY 277/480 Red	VSI63R507	VSI63P507	VSI125R507	VSI125P507
	3 ØY 347/600 Black	VSI63R505	VSI63P505	VSI125R505	VSI125P505

VSI non-metallic devices NOT intermateable with Versamate® NEC metallic series.

PLUG DUST CAP	
FOR PLUG TYPE	CATALOG NUMBER
VSI63P4__	VSI63801140
VSI63P5__	VSI63801140
VSI125P4__	VSI125801140
VSI125P5__	VSI125801140

Dust cap shall be installed on the plug when the plug is not engaged in the receptacle.

TECHNICAL DATA			
RECEPTACLE		63 AMP	125 AMP
ENCLOSURE MATERIAL		FIBER REINFORCED POLYESTER	
AMBIENT TEMPERATURE, T _A		-20°C (-4°F) to +40°C (104°F)	
TERMINAL CAPACITY		2 wires, 90°C rated	
		6-1/0 AWG	1/0-3/0 AWG
SWITCH RATING	(Horsepower)	3-phase	3-phase
	120 VAC	10 HP	20 HP
	240 VAC	20 HP	40 HP
	480 VAC	40 HP	100 HP
	600 VAC	60 HP	125 HP
LINE SUPPLY FUSE		CLASS J - size per NEC/CEC requirement, upstream ahead of unit	
BOTTOM ENTRY		1-1/2" NPT	2" NPT

TECHNICAL DATA		
PLUG	63 AMP	125 AMP
ENCLOSURE MATERIAL	POLYAMIDE	
TERMINAL CAPACITY	1 wire, 90°C rated	
	10-4 AWG	6-1/0 AWG
CORD OUTER DIA.	0.94" - 1.4"	1.2" - 2"



VERSAMATE® SERIES

VSI NON-METALLIC PLUGS AND SWITCHED RECEPTACLES

Dimensions
NOTE: Drawings are not to scale

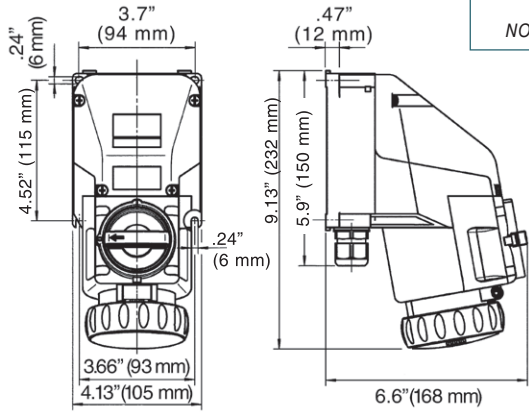

RECEPTACLE 20A
2 POLE - 3 WIRE

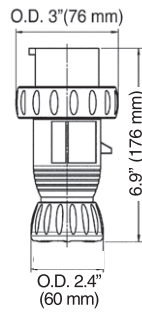

PLUG 20A

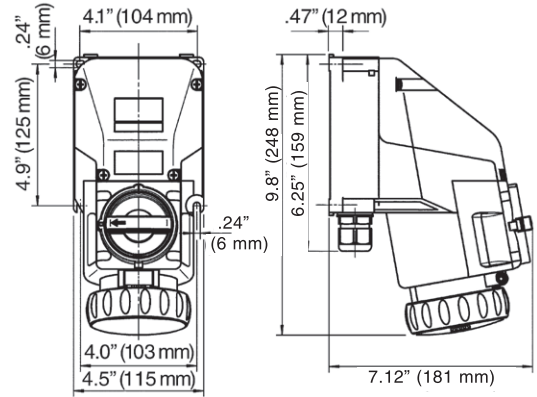

RECEPTACLE 20A
3 POLE - 4 WIRE AND 4 - POLE 5 WIRE

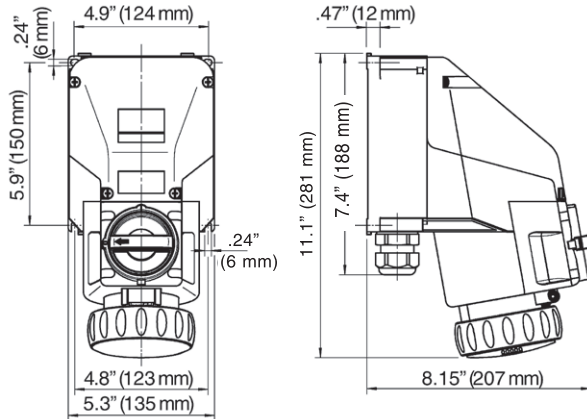

RECEPTACLE 30A
3 POLE - 4 WIRE AND 4 POLE - 5 WIRE

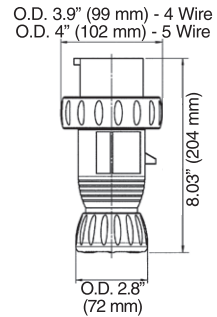

PLUG 30A

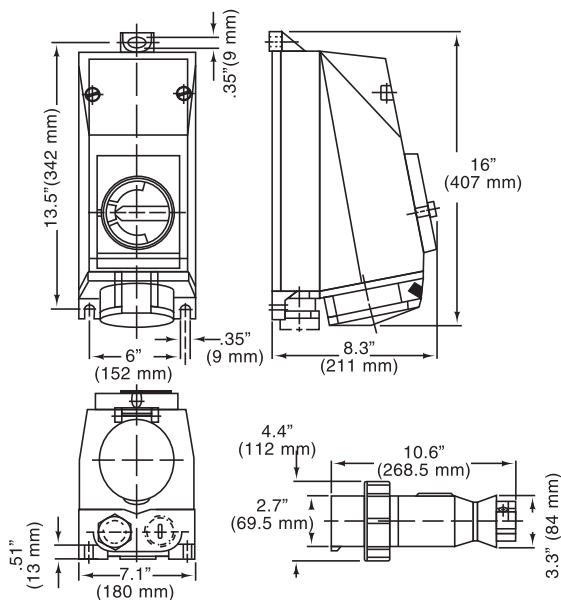

RECEPTACLE & PLUG 63A
3 POLE - 4 WIRE AND 4 POLE - 5 WIRE

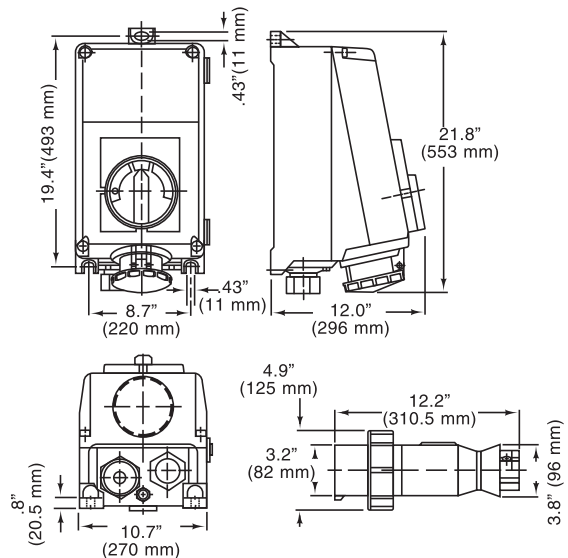

RECEPTACLE & PLUG 125A
3 POLE - 4 WIRE AND 4 POLE - 5 WIRE



HAZARDOUS LOCATION – DELAYED ACTION

UL LISTED E23572

SP® Certified LR14667®

Class I, Div. 1 & 2, Groups C, D
Class I, Zones 1 & 2, IIB, IIA
NEMA 7 (C, D)

FEATURES-SPECIFICATIONS

Applications

KR Series plugs and receptacles are suitable:

- In hazardous locations due to the presence of flammable vapors or gases
- Where a heavy duty plug and receptacle is necessary
- Where a connection is required for portable or movable equipment such as tools, motors, hand lights, etc.
- KP series plugs use solder terminations for sure connection
- KR series receptacles use wire leads for termination

Features

- Factory sealed receptacles
- Copper free aluminum
- Straight or angle type receptacles
- Delayed action contacts (See Time Delay Inset)
- Plugs with a wide range of grommet openings
- Extra long grounding pole makes contact first and breaks contact last
- Heavy duty construction to withstand rough and constant usage

Selection

Refer to page headings for suitability of specific items. When selecting a Killark device consider the following:

- (A) Installation area (Hazardous or Weather-Resistant)
- (B) Amperage
- (C) Voltage
- (D) Electrical Rating (see below)
- (E) Grounding
- (G) Modifications (see right)
- (H) Mounting arrangement
- (I) Box and hub type
- (J) Cord diameter

① CSA approval on 20 Amp only.
UL for 20-60 AMP

Details of Safety Time Delay Feature

The key slot provided in the receptacle engages the key of the plug permitting entrance of the plug in the receptacle in only one position. See steps 1-4.

The contacts are enclosed in long accurate insulating cavities. It is in these cavities that the arcs are extinguished. All contacts are made through round tellurium copper tubing which is extra heavy to withstand arcing as required on the various ampere ratings.

Both plugs and receptacles are equipped with an extra long grounding pole which establishes grounding before the power contacts are engaged. These grounding poles are also the last to break contact. This assures bonding of the portable device to the electrical conduit system.

Selection

Modifications are available by adding the following suffix (SU37 or SU38) to the catalog number and can be used to prevent mismatched voltage connections. (Note: It must be added to both the plug and the receptacle so they will mate.)

MODIFICATIONS	
CATALOG NUMBER	DESCRIPTION
SU37	Interior contact assemblies are to be rotated 22-1/2° to the right.
SU38	Interior contact assemblies are to be rotated 22-1/2° to the left.

Safety Time Delay Feature

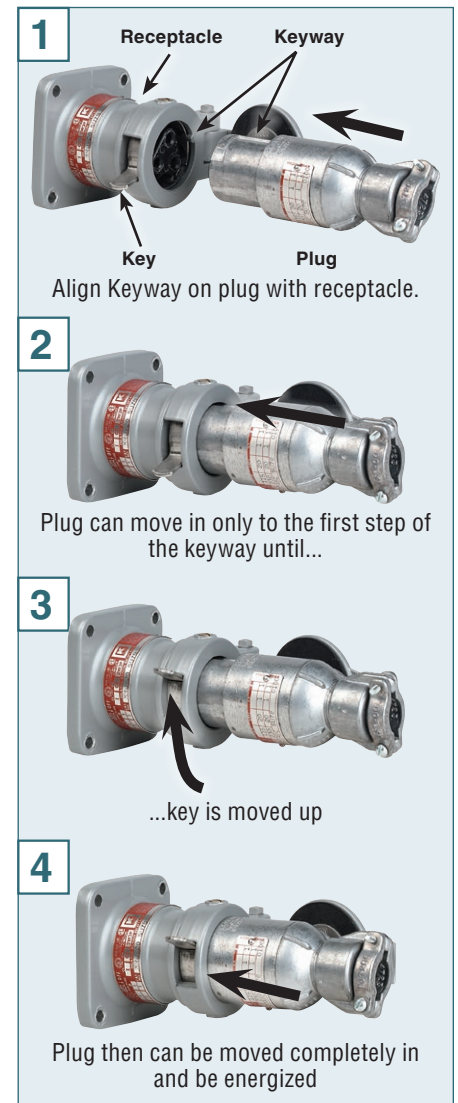

ELECTRICAL RATINGS					
TYPE	AMPERAGE	VOLTAGE VAC	CIRCUIT	H.P.	HERTZ
①20 AMP	20	115/230	2W3P	1	60
30 AMP	7	460	2W3P	1/2	60
	7	460	3W4P	1	60
	30	115/230	2W3P	1-1/2	60
	30	115/230	3W4P	3	60
60 AMP	30	460	2W3P	3	60
	30	460	3W4P	5	60
	60	115/230	2W3P	5	60
	60	115/230	3W4P	5	60



KR SERIES

20 AMP 115/230 V.A.C • 1Ø 2 WIRE, 3 POLE



KRS Series



KRA



Plug

Class I, Div. 1 & 2, Groups C, D^①
Class I, Zones 1 & 2, IIB, IIA
NEMA 7 (C, D)

UL LISTED File No. E23572

SP Certified File No. LR14667

FEATURES-SPECIFICATIONS

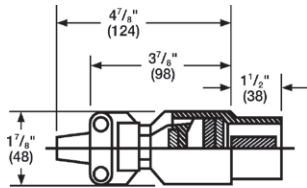

KP 20 AMP PLUG	
CATALOG NO.	DESCRIPTION
KP-20ABC	Plug furnished with 3 grommets range .250 - .625

See page PR22 for available polarization options.

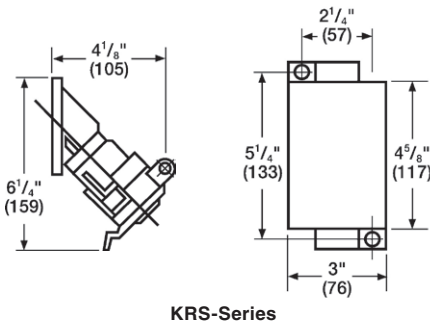

KRS-Series

KRS 20A 1Ø 2W RECEPTACLE WITH SWB BOX ^②								
HUB SIZE	CATALOG NUMBER							
	SINGLE RECEPTACLE & DEAD END BOX	BOX ONLY	SINGLE RECEPTACLE & FEED-THRU BOX	BOX ONLY	DOUBLE RECEPTACLE & DEAD END BOX	BOX ONLY	DOUBLE RECEPTACLE & FEED-THRU BOX	BOX ONLY
1/2"	KRS-215-120	SWB-1	KRS-218-120	SWB-4	2KRS-215-120	SWB-7	2KRS-218-120	SWB-10
3/4"	KRS-215-220	SWB-2	KRS-218-220	SWB-5	2KRS-215-220	SWB-8	2KRS-218-220	SWB-11
1"	KRS-215-320	SWB-3	KRS-218-320	SWB-6	2KRS-215-320	SWB-9	2KRS-218-320	SWB-12

RECEPTACLE ONLY – CATALOG NUMBER KRS-20

① KRS Series receptacles - Class I, Group D.

② SWB Series mounting splice boxes only for receptacles shown above listed in Section C of full-line catalog. See page PR22 for available polarization options.

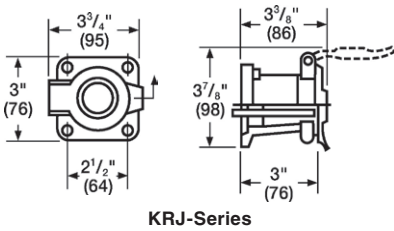

KRJ-Series



AJC



JLC

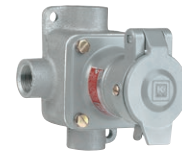

JLX

KRJ RECEPTACLE WITH AJ OR JL BOX			
HUB SIZE	CATALOG NUMBER		
	AJC	JLC	JLX
1/2"	—	KRJC-120	KRJC-120
3/4"	KRAJC-220	KRJC-220	KRJC-220
1"	KRAJC-320	—	—

BACK BOX ONLY			
1/2"	—	JLC-1	JLX-1
3/4"	AJC-2	JLC-2	JLX-2
1"	AJC-3	—	—

RECEPTACLE ONLY – CATALOG NUMBER KRJ-20

JL Series boxes shown in Section F of full-line catalog. Refer to page headings for suitability of specific items. See page PR22 for available polarization options.

ELECTRICAL RATING	
CIRCUIT	RATING (60 HERTZ)
1Ø 2W3P	20 AMPS, 115/230 V.A.C., 1 H.P

CONNECTORS

KR SERIES



30 AMP 115/230 V.A.C. • 7 AMP 460 V.A.C

KRS/KRJ Series Plug

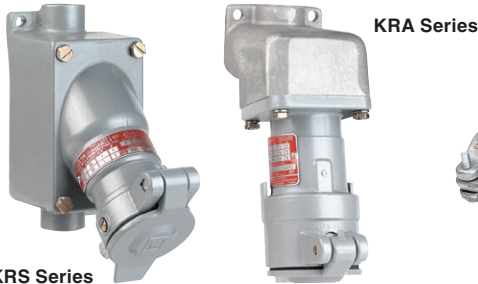

Plug

Class I, Div. 1 & 2, Groups C,D^①
Class I, Zones 1 & 2, IIB, IIA
NEMA 7 (C,D)

UL LISTED - File E23572
 See files for details or call Killark.

KRS Series

FEATURES-SPECIFICATIONS

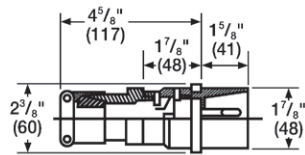

D Type

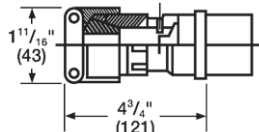

E Type

KP 30 AMP PLUG			
CATALOG NUMBER		PLUG TYPE	GROMMET RANGE
1Ø, 2-WIRE, 3-POLE	3Ø, 3-WIRE 4-POLE		
KP-303D23	KP-304D23	D	.375-.625
KP-303D45	KP-304D45	D	.625-.875
KP-303E45	KP-304E45	E	.875-1.125
KP-303E67	KP-304E67	E	1.125-1.375

See page PR22 for available polarization options.

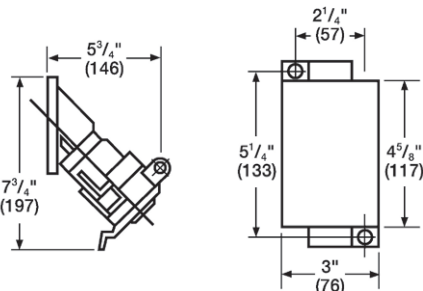

KRS-Series

KRS RECEPTACLE WITH SWB BOX ^②								
HUB SIZE	CATALOG NUMBER - SINGLE GANG ONLY							
	1Ø, 2-WIRE, 3-POLE DEAD END BOX	BOX ONLY	1Ø, 2-WIRE, 3-POLE FEED THRU BOX	BOX ONLY	3Ø, 3-WIRE, 4-POLE DEAD END BOX	BOX ONLY	3Ø, 3-WIRE, 4-POLE FEED THRU BOX	BOX ONLY
1/2"	KRS-215-1303	SWB-1	KRS-218-1303	SWB-4	KRS-215-1304	SWB-1	KRS-218-1304	SWB-4
3/4"	KRS-215-2303	SWB-2	KRS-218-2303	SWB-5	KRS-215-2304	SWB-2	KRS-218-2304	SWB-5
1"	KRS-215-3303	SWB-3	KRS-218-3303	SWB-6	KRS-215-3304	SWB-3	KRS-218-3304	SWB-6
RECEPTACLE ONLY	KRS-303				KRS-304			

^① KRS Series receptacles - Class I, Group D.

^② SWB Series mounting splice boxes for receptacles shown above listed in Section C of full-line catalog. Two gang models not available. See page PR22 for available polarization options.

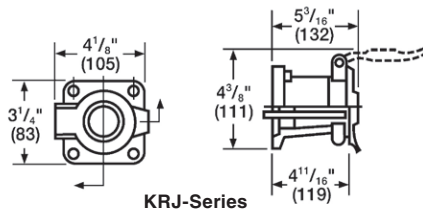

KRJ-Series



AJC

JLC

JLX

ELECTRICAL RATING	
CIRCUIT	RATING (60 HERTZ)
1 Ø	7 Amps, 460 V.A.C., 1½ H.P.
2-Wire	- OR -
3-Pole	30 Amps, 115/230 V.A.C., 1-1½ H.P.
3 Ø	7 Amps, 460 V.A.C., 1 H.P.
3-Wire	- OR -
4-Pole	30 Amps, 115/230 V.A.C., 3 H.P.

KRJ RECEPTACLE WITH AJ OR JL BOX				
CIRCUIT	HUB SIZE	CATALOG NUMBER		
		AJC	JLC	JLX
1Ø 2-Wire 3-Pole	1/2"	—	KRJC-1303	KRJX-1303
	3/4"	KRAJC-2303	KRJC-2303	KRJX-2303
	1"	KRAJC-3303	—	—
RECEPTACLE ONLY - CATALOG NUMBER KRJ-303				
3Ø 3-Wire 4-Pole	1/2"	—	KRJC-1304	KRJX-1304
	3/4"	KRAJC-2304	KRJC-2304	KRJX-2304
	1"	KRAJC-3304	—	—
RECEPTACLE ONLY - CATALOG NUMBER KRJ-304				
Back Box Only	1/2"	—	JLC-1	JLX-1
	3/4"	AJC-2	JLC-2	JLX-2
	1"	AJC-3	—	—

JL Series boxes shown in Section F of full-line catalog. Refer to page headings for suitability of specific items. See page PR22 for available polarization options.



KR SERIES

60 AMP 115/230 V.A.C. • 30 AMP/460 V.A.C.



Class I, Div. 1 & 2, Groups C, D
Class I, Zones 1 & 2, IIB, IIA
NEMA 7 (C, D)

LISTED File No. E23572

FEATURES-SPECIFICATIONS

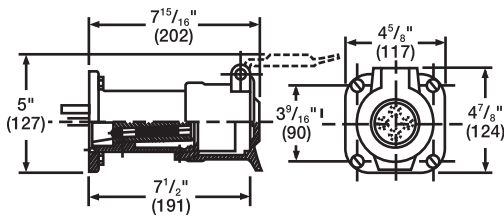

KRJ-60 Type Receptacles

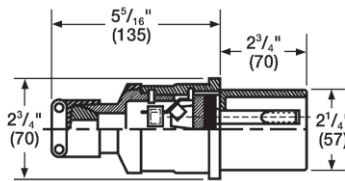

KP Type Plugs

KR 60 AMP PLUGS		
CATALOG NUMBER		GROMMET RANGE
1Ø, 2-WIRE, 3-POLE	3Ø, 3-WIRE 4-POLE	
KP-603D345	KP-604D345	.500-.875
KP-603E45	KP-604E45	.875-1.125
KP-603E67	KP-604E67	1.125-1.375
—	KP-604F34	1.250-1.500
—	KP-604F56	1.500-1.750

See page PR22 for available polarization options.

Dimensions-Back Boxes

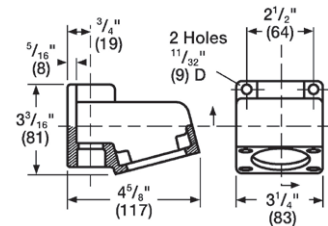

AJAC Types

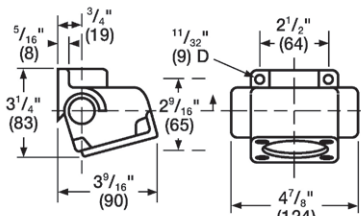

AJAT Type

KR RECEPTACLE ASSEMBLIES

HUB SIZE	BOX STYLE	HUB STYLE	CATALOG NUMBER			
			1Ø, 2-WIRE 3-POLE	3Ø, 3-WIRE 4-POLE	SPLICE BOX ONLY	
1"	JAL Series Boxes	"X"-3 Close-up Plugs Supplied	KRJX-3603	KRJX-3604	JALX-3	
1-1/4"			KRJX-4603	KRJX-4604	JALX-4	
1-1/4"	AJA Series Boxes	Feed Thru Top and Bottom	KRAJAC-4603	KRAJAC-4604	AJAC-4	
1-1/2"			KRAJAC-5603	KRAJAC-5604	AJAC-5	
2"			KRAJAC-6603	KRAJAC-6604	AJAC-6	
1-1/4"			T Sides and Top	KRAJAT-4603	KRAJAT-4604	AJAT-4
1-1/2"				KRAJAT-5603	KRAJAT-5604	AJAT-5
RECEPTACLE ONLY			KRJ-603	KRJ-604	—	

NOTE: For dead end box, use AJAC Series and CUP Series close-up plug.
 See page PR22 for available polarization options.

ELECTRICAL RATING	
CIRCUIT	RATING (60 HERTZ)
1 Ø	30 Amps, 460 V.A.C., 3 H.P.
2-Wire	— OR —
3-Pole	60 Amps, 115/230 V.A.C., 3 H.P.
3 Ø	30 Amps, 460 V.A.C., 5 H.P.
3-Wire	— OR —
4-Pole	60 Amps, 115/230 V.A.C., 5 H.P.

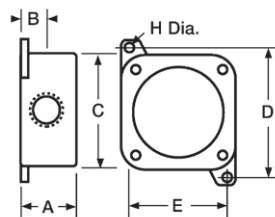

JAL Type

JAL TYPE MOUNTING BOXES						
HUB	A	B	C	D	E	H
1"	2-3/8"	1-5/32"	4-5/8"	5-1/4"	4-1/8"	5/16"
1-1/4"	3-1/8"	1-17/32"	4-5/8"	5-1/4"	4-1/8"	5/16"



XP STARLINE FEATURES

The **Vantage** Star-Line Series of explosionproof connectors is offered in a variety of materials and configurations. Product options and an array of third party listings mean we have a solution for your application. Note, options and features may vary based on third party listing.

PLUG, ATTACHMENT

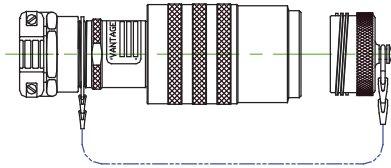

PLUG, TAPPED NPT

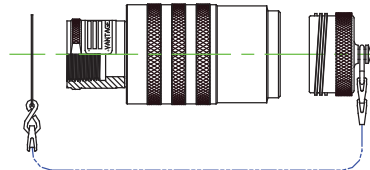

RECEPTACLE, JUNCTION BOX

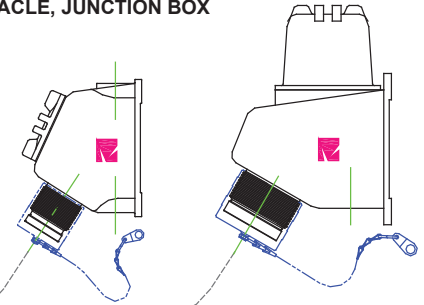

RECEPTACLE, NPT

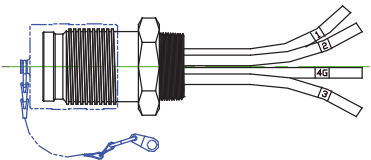

RECEPTACLE, PANEL MOUNT

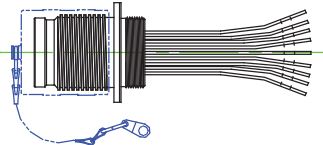

RECEPTACLE, ATTACHMENT

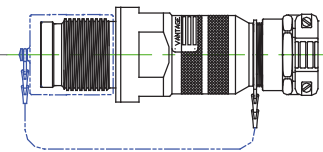

RECEPTACLE, TAPPED NPT

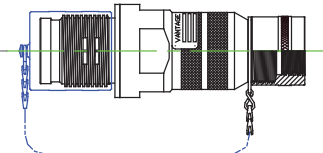

Features

- **Sealing.** All junction box, NPT and panel mount receptacles are pre-wired and factory sealed eliminating the need for external seals.
- **Purged / Pressurized Systems.** Factory sealing makes our receptacles ideal for use with these technologies.

Options

- **Covers.** Environmental threaded covers are standard with all connectors.
- **Pigtails.** Receptacle leads may be ordered in any length.
- **Gender.** Connectors can be supplied with reverse service inserts when lineside power is carried in the plug to the receptacle.
- **Keying.** Inserts can be keyed for phase and voltage separation.
- **Color Coding.** Connectors may be ordered in a range of colors and combinations of color.
- **Custom Assemblies.** Are available to user's specifications.

VICTORY SERIES MACHINED, HARD ANODIZED ALUMINUM			
GD POWER PAGE CN46	II 2 GD EEx d IIC T6 IP 66/67 T 70°C	Class I, Division 1, Groups B, C & D Class II, Division 1, Groups F & G	Class I, Division 1, Groups C & D
AF CONTROL PAGE CN48			
MILLENNIUM SERIES STAINLESS STEEL, ALLOY 316			
SD POWER PAGE CN51	II 2 GD EEx d IIC T6 IP 66/67 T 70°C	Class I, Division 1, Groups B, C & D Class II, Division 1, Groups F & G	
SF CONTROL PAGE CN51			Class I, Division 1, Groups B, C & D Class II, Division 1, Groups F & G



EXPLOSIONPROOF STARLINE

FEATURES • ALUMINUM VICTORY GD SERIES POWER



Ratings & Certifications:

- Class I, Div. 1 & 2, Groups C & D at 480VAC; 60/400 Hz, Circuit-Breaking
- Class I, Div 1 & 2, Groups B, C & D Class II, Div.1, Groups F & G at 600VAC, 60/400 Hz, Circuit-Breaking. AEx d IIC T6
- II 2 GD Ex d IIC IP 66/67 T 70°C 1000VAC, 500VDC

PRODUCT FEATURES

- **Power Inserts:** 30 to 260 amp rated for service through 600VAC
- **Control Inserts:** Multi-pin inserts can be specified for either crimp or solder termination with contacts whose size and amp ratings are as follows: Inserts with the highest contact density per shell size are:

Shell 16	61 - #18 AWG contacts
Shell 20	90 - #18 AWG contacts
Shell 24	100 - #16 AWG contacts

- **Voltage:** Control connectors tested for service through 250 VAC / 125 VDC, select inserts through 480 VAC non-circuit breaking. Power connectors have been tested for service through 600 VAC (GSA) & 1000 VAC / 500 VDC (KEMA)
- **Frequency:** Tested at both 60 and 400 Hz. This feature is of paramount importance at airports and aircraft maintenance facilities around the world.
- **Circuit-Breaking:** UL and CSA Listed to make/break at full rated load, these connectors were required to pass an overload test of 50 cycles at 150% of their ampere rating in a chamber filled with a test mixture of hazardous vapors.

PIN - SOCKET WIRE SIZE	AMPS	
18 AWG (.75 mm ²)	3.5	10
16 AWG (1.5 mm ²)	6.5	15
12 AWG (4.0 mm ²)	10	20
8 AWG / (10 mm ²)	30	32
4 AWG / (25 mm ²)	60	63
1/0 AWG / (55 mm ²)	100	125
4/0 (120 mm ²)	200	260

- **Corrosion Resistance** Designed for corrosive environments, junction boxes are sand cast, copper-free aluminum, protected by our VanGuard baked polymer finish system. Plug and receptacle shells are machined from 6061-T6 aluminum (0.15 to 0.40% copper by weight) and finished by hard anodizing.



- **Alternate Keyed Inserts** For added safety, inserts can be keyed in alternate positions to prevent mating of differing voltages, frequencies or services.
- **Factory Sealing** Junction box, NPT and panel-mounted receptacles are pre-wired and factory sealed. No external seals are required.
- **Insert Patterns** Grounding inserts with 3, 4, 5, and 6 contacts are described as 2 Pole 3 Wire, 3 Pole 4 Wire, 4 Pole 5 Wire, and 3 Pole 4 Wire plus 2 relay length contacts. The ground pin is longer and will make first - break last, an important safety feature.
- **Reverse Service** GD connectors were the first explosionproof connectors to secure both UL and CSA listing with reverse service inserts. Their ATEX listing also supports reverse service. This feature provides electrical safety where lineside power is carried from the plug to a receptacle.
- **Color Coding** Plugs and receptacles are available with color coding variations for specific application identification. This coding could include the plug coupling nut and cover with matching colors on various receptacle components.



RECEPTACLE STYLES

JUNCTION BOX	ATTACHMENT	PANEL MOUNT	NPT MOUNT	TAPPED FLEXIBLE CONDUIT

CONNECTORS

EXPLOSIONPROOF STARLINE



CODE LOGIC • GD & SD RECEPTACLES

GD	-	B	17	16	-	23	S	L	01	-	FH	-	XX
1		2	3	4		5	6	7	8		9		10

- 1. Classification** GD / SD = Groups B-C-D areas & Ex d IIC T6 IP 66/67 T70°
 GDU / SDU = Groups B-C-D areas & Ex d IIC T6 IP 66/67 T70°
 GDT / SDT = Groups B-C-D areas & Ex d IIC T6 IP 66/67 T70°
- 2. Cover** B = Cover
- 3. Shell Style** 17 = Receptacle for Junction Box or Panel-mount
 19 = Receptacle for NPT-mount
- 4. Shell Size** 16 = Shell Size 16
 20 = Shell Size 20
 24 = Shell Size 24
 28 = Shell Size 28
- 5. Insert** 30 through 260 amps – through 1000 VAC. See Insert Code column in Insert Table below.
- 6. Gender** S = Female (Socket) Insert P = Male (Pin) Insert
- 7. Contact Plating** L = Silver Plate (Standard). Ground contacts are gold over silver.
- 8. Insert Keying** Blank = Normal Key Alternate = See Key Positions column in Insert Table.
- 9. Hub Accessory** See Junction Box Table Blank = Panel / 17 Style or NPT / 19 Style
- 10. Wire Lead Variation** See Wire Length Table Per customer requirements.

Shell Size 16 = 1 ½" NPT
 Shell Size 20 = 2" NPT
 Shell Size 24 = 2 ½" NPT
 Shell Size 28 = 3" NPT

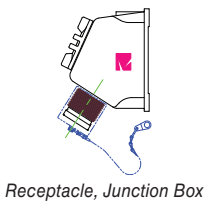

Receptacle, Junction Box

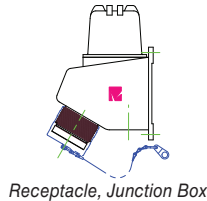

Receptacle, Junction Box

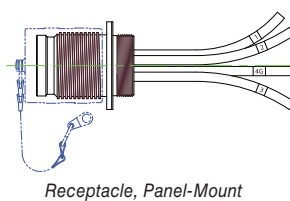

Receptacle, Panel-Mount

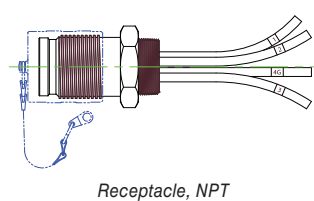

Receptacle, NPT

INSERT TABLE						
AMPERES			INSERT	SHELL SIZE	INSERT CODE	KEY POSITIONS ¹
UL	SR ^{us}	Ex				
30	32		2 POLE, 3 WIRE	16	51	N + 5
			3 POLE, 4 WIRE	16	23	N + 5
			4 POLE, 5 WIRE	20	36	N + 2
60	63		2 POLE, 3 WIRE	20	61	N + 7
			3 POLE, 4 WIRE	20	40	N + 4
100	125		4 POLE, 5 WIRE	24	29	N + 3
			2 POLE, 3 WIRE	24	60	N + 7
			3 POLE, 4 WIRE	24	39	N + 5
200	260		4 POLE, 5 WIRE	28	23	N + 3
			2 POLE, 3 WIRE	28	30	N + 9
			3 POLE, 4 WIRE	28	31	N + 10
			5 POLE 6 WIRE (3 POLE 4 WIRE and 2 relay contacts)	28	42	N + 3

1. NORMAL KEY POSITION = N; ALTERNATE KEYS = 01, 02, ETC.

WIRE LENGTH		
CODE	LENGTH	
	INCHES	METERS
L12	12	0.31
L24	24	0.61
L36	36	0.91
Etc	Etc	

JUNCTION BOX		
SHELL SIZE	CONDUIT HUB LOCATION	CONDUIT HUB SIZE (INCHES)
16 & 20	'F' TOP & BOTTOM	'H' 1½ - 11½ NPT
24	'B' BOTTOM	'K' 2½ - 8 NPT
28	'B' BOTTOM	'L' 3 - 8 NPT

Example: Suffix "-FH" denotes thru feed with a 1½ inch hub

Note: Code logic is provided to identify features called out by standard part numbers. Not all component codes are compatible with all others. Reference part number tables under appropriate product sections of this catalog or consult Vantage Technology.



EXPLOSIONPROOF STARLINE

CODE LOGIC • GD & SD ATTACHMENT CONNECTORS

GD	-	D	10	16	-	51	P	L	01	-	XX	-	XX
1		2	3	4		5	6	7	8		9		10

- 1. Classification** GD / SD = Groups B-C-D areas & Ex d IIC T6 IP 66/67 T70°
 GDU / SDU = Groups B-C-D areas & Ex d IIC T6 IP 66/67 T70°
 GDT / SDT = Groups B-C-D areas & Ex d IIC T6 IP 66/67 T70°
- 2. Cover** Blank = No Cover
 B = Cover / Receptacle
 D = Cover / Plug
- 3. Shell Style** 10 = Plug, Attachment Style
 15 = Receptacle, Attachment Style
- 4. Shell Size** 16 = Shell Size 16
 20 = Shell Size 20
 24 = Shell Size 24
 28 = Shell Size 28
- 5. Insert** 30 through 260 amps – through 1000 VAC. See Insert Code column in Insert Table below.
- 6. Gender** S = Female (Socket) Insert P = Male (Pin) Insert
- 7. Contact Plating** L = Silver Plate (Standard). Ground contacts are gold over silver.
- 8. Insert Keying** Blank = Normal Key Alternate = See Key Positions column in Insert Table.
- 9. Grommet** Replace XX with cable diameter code number from Page CN66 TC = Tapped Conduit

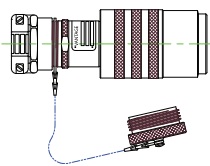

Plug, Attachment

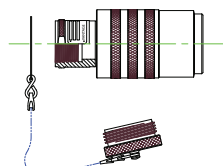

Plug, Conduit Tapped

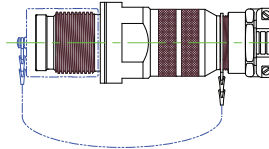

Receptacle, Attachment

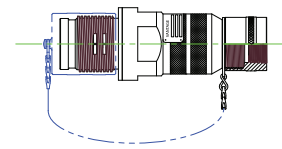

Receptacle, Conduit Tapped

AMPERES		INSERT	SHELL SIZE	INSERT CODE	KEY POSITIONS ¹
UL	CSA US				
30	32	2 POLE, 3 WIRE	16	51	N + 5
		3 POLE, 4 WIRE	16	23	N + 5
		4 POLE, 5 WIRE	20	36	N + 2
60	63	2 POLE, 3 WIRE	20	61	N + 7
		3 POLE, 4 WIRE	20	40	N + 4
		4 POLE, 5 WIRE	24	29	N + 3
100	125	2 POLE, 3 WIRE	24	60	N + 7
		3 POLE, 4 WIRE	24	39	N + 5
		4 POLE, 5 WIRE	28	23	N + 3
200	260	2 POLE, 3 WIRE	28	30	N + 9
		3 POLE, 4 WIRE	28	31	N + 10
		5 POLE 6 WIRE (3 POLE 4 WIRE and 2 relay contacts)	28	42	N + 3

Note: Code logic is provided to identify features called out by standard part numbers. Not all component codes are compatible with all others. Reference part number tables under appropriate product sections of this catalog or consult Vantage Technology

1. NORMAL KEY POSITION = N; ALTERNATE KEYS = 01, 02, ETC.



CODE LOGIC • AF & SF RECEPTACLES

AF	-	B	17	16	-	655	S	L	K	01	-	FH	-	XXX
1		2	3	4		5	6	7	8	9		10		11

- 1. Classification** AF = Groups B-C-D areas & Ex d IIC T6 IP 66/67 T70°
SF = Groups B-C-D areas & Ex d IIC T6 IP 66/67 T70°
- 2. Cover** B = Cover
- 3. Shell Style** 17 = Receptacle for Box or Panel-mount
19 = Receptacle for NPT-mount
- 4. Shell Size** 16 = Shell Size 16
20 = Shell Size 20
24 = Shell Size 24
28 = Shell Size 28
- 5. Insert** 10 through 100 contacts; See Insert Code column in Insert Table below.
- 6. Gender** S = Female (Socket) Insert P = Male (Pin) Insert
- 7. Contact Type** L = Crimp Contacts
- 8. Contact Plating** Blank = Standard Silver K = Gold over silver D = Gold over nickel
- 9. Insert Keying** Blank = Normal Key Alternate = See Key Positions column in Insert Table
- 10. Hub Accessory** See Junction Box Table Blank = Panel / 17 Style or NPT / 19 Style

Shell Size 16 = 1 1/2" NPT
Shell Size 20 = 2" NPT
Shell Size 24 = 2 1/2" NPT
Shell Size 28 = 3" NPT

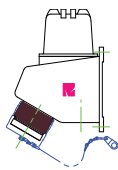

Receptacle, Junction Box



Receptacle, Junction Box

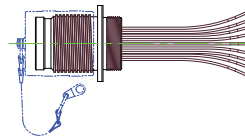

Receptacle, Panel-Mount

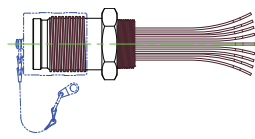

Receptacle, NPT

INSERT TABLE				
CONTACT QUANTITY	PIN SIZE AWG (MM ²)	SHELL SIZE	INSERT CODE	KEY POSITIONS ¹
10	#12 (4.0)	16	681	N + 4
10	#12 / G (4.0)	16	676	N + 1
19	#12 / G (4.0)	16	612	N + 4
19	#12 (4.0)	16	677	N + 1
19	#12 (4.0)	20	676	N + 5
19	#12 / G (4.0)	20	688	N
19	#16 (1.5)	16	655	N + 9
20	#12 (4.0)	20	632	N + 3
20	#12 / G (4.0)	20	687	N + 1
37	#12 (4.0)	20	686	N
37	#12 / G (4.0)	20	650	N + 3
37	#16 (1.5)	16	621	N + 9
55	#18 (.75)	16	640	N + 10
61	#18 (.75)	16	633	N + 4
68	#16 (1.5)	20	613	N + 4
100	#16 (1.5)	24	613	N + 4

1. NORMAL KEY POSITION = N; ALTERNATE KEYS = 01, 02, ETC.

CODE	LENGTH	
	INCHES	METERS
L12	12	0.31
L24	24	0.61
L36	36	0.91
Etc	Etc	

JUNCTION BOX		
SHELL SIZE	CONDUIT HUB LOCATION	CONDUIT HUB SIZE (INCHES)
16 & 20	'F' TOP & BOTTOM	'H' 1 1/2 - 1 1/2 NPT
24	'B' BOTTOM	'K' 2 1/2 - 8 NPT
28	'B' BOTTOM	'L' 3 - 8 NPT

Example: Suffix "-FH" denotes thru feed with a 1/2 inch hub



EXPLOSIONPROOF STARLINE

CODE LOGIC • AF & SF ATTACHMENT CONNECTORS

AF	-	D	10	16	-	621	P	L	K	01	-	XX	-	XXX
1		2	3	4		5	6	7	8	9		10		11

- Classification**
AF = Groups B-C-D areas & Ex d IIC T6 IP 66/67 T70°
SF = Groups B-C-D areas & Ex d IIC T6 IP 66/67 T70°
- Cover**
Blank = Cover
B = Cover / Receptacle
D = Cover / Plug
- Shell Style**
10 = Plug, Attachment
15 = Receptacle, Attachment
- Shell Size**
16 = Shell Size 16
20 = Shell Size 20
24 = Shell Size 24
28 = Shell Size 28
- Insert**
10 through 100 contacts; See Insert Code column in Insert Table below.
- Gender**
S = Female (Socket) Insert P = Male (Pin) Insert
- Contact Plating**
L = Standard Silver K = Gold over silver D = Gold over nickel
- Insert Keying**
Blank = Normal Key Alternate = See Key Positions column in Insert Table
- Grommet**
Replace XX with cable diameter code number from Page CN66
TC = Tapped Conduit
B = Basket Weave
- Wire Lead Variation** See Wire Length Table. Per customer requirements.

INSERT TABLE				
CONTACT QUANTITY	PIN SIZE AWG (MM ²)	SHELL SIZE	INSERT CODE	KEY POSITIONS ¹
10	#12 (4.0)	16	681	N + 4
10	#12 / G (4.0)	16	676	N + 1
19	#12 / G (4.0)	16	612	N + 4
19	#12 (4.0)	16	677	N + 1
19	#12 (4.0)	20	676	N + 5
19	#12 / G (4.0)	20	688	N
19	#16 (1.5)	16	655	N + 9
20	#12 (4.0)	20	632	N + 3
20	#12 / G (4.0)	20	687	N + 1
37	#12 (4.0)	20	686	N
37	#12 / G (4.0)	20	650	N + 3
37	#16 (1.5)	16	621	N + 9
55	#18 (.75)	16	640	N + 10
61	#18 (.75)	16	633	N + 4
68	#16 (1.5)	20	613	N + 4
100	#16 (1.5)	24	613	N + 4

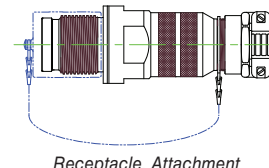
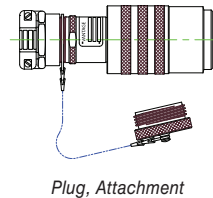
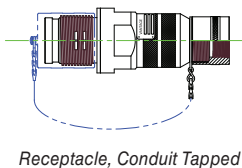
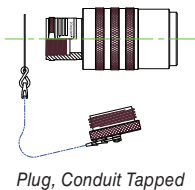

1. NORMAL KEY POSITION = N; ALTERNATE KEYS = 01, 02, ETC.

Note: Code logic is provided to identify features called out by standard part numbers. Not all component codes are compatible with all others. Reference part number tables under appropriate product sections of this catalog or consult Vantage Technology.

CONNECTORS

EXPLOSIONPROOF STARLINE

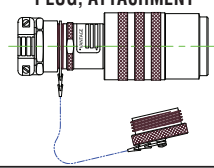
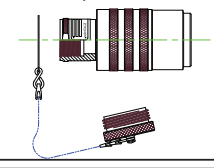
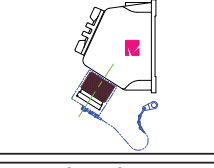
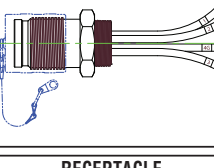
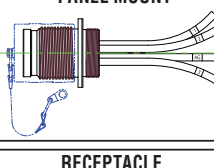
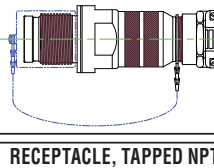
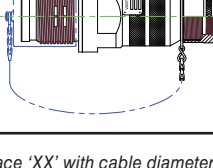

GD PART NUMBERS

	AMPERES		2 POLE, 3 WIRE	3 POLE, 4 WIRE	3 POLE, 4 WIRE + 2 RELAY	4 POLE, 5 WIRE
	UL	Ex				
PLUG, ATTACHMENT 	30 / 32		GD-D1016-51PL-XX	GD-D1016-23PL-XX		GD-D1020-36PL-XX
	60 / 63		GD-D1020-61PL-XX	GD-D1020-40PL-XX	GD-D1020-56PL-XX	GD-D1024-29PL-XX
	100 / 125		GD-D1024-60PL-XX	GD-D1024-39PL-XX	GD-D1024-32PL-XX	GD-D1028-23PL-XX
	200 / 260		GDU-D1028-30PL-XX	GDU-D1028-31PL-XX	GDT-D1028-42PL-XX	
PLUG, TAPPED NPT 	30 / 32		GD-D1016-51PL-TC	GD-D1016-23PL-TC		GD-D1020-36PL-TC
	60 / 63		GD-D1020-61PL-TC	GD-D1020-40PL-TC	GD-D1020-56PL-TC	GD-D1024-29PL-TC
	100 / 125		GD-D1024-60PL-TC	GD-D1024-39PL-TC	GD-D1024-32PL-TC	GD-D1028-23PL-TC
	200 / 260		GDU-D1028-30PL-TC	GDU-D1028-31PL-TC	GDT-D1028-42PL-TC	
RECEPTACLE, JUNCTION BOX 	30 / 32		GD-B1716-51SL-FH	GD-B1716-23SL-FH		GD-B1720-36SL-FH
	60 / 63		GD-B1720-61SL-FH	GD-B1720-40SL-FH	GD-B1720-56SL-FH	GD-B1724-29SL-BK
	100 / 125		GD-B1724-60SL-BK	GD-B1724-39SL-BK	GD-B1724-32SL-BK	GD-B1728-23SL-BL
	200 / 260		GDU-B1728-30SL-BL	GDU-B1728-31SL-BL	GDT-B1728-42SL-BL	
RECEPTACLE, NPT 	30 / 32		GD-B1916-51SL-L48	GD-B1916-23SL-L48		GD-B1920-36SL-L48
	60 / 63		GD-B1920-61SL-L48	GD-B1920-40SL-L48	GD-B1920-56SL-L48	GD-B1924-29SL-L48
	100 / 125		GD-B1924-60SL-L48	GD-B1924-39SL-L48	GD-B1924-32SL-L48	GD-B1928-23SL-L48
	200 / 260		GDU-B1928-30SL-L48	GDU-B1928-31SL-L48	GDT-B1928-42SL-L48	
RECEPTACLE, PANEL MOUNT 	30 / 32		GD-B1716-51SL-L36	GD-B1716-23SL-L36		GD-B1720-36SL-L36
	60 / 63		GD-B1720-61SL-L36	GD-B1720-40SL-L36	GD-B1720-56SL-L36	GD-B1724-29SL-L36
	100 / 125		GD-B1724-60SL-L36	GD-B1724-39SL-L36	GD-B1724-32SL-L36	GD-B1728-23SL-L36
	200 / 260		GDU-B1728-30SL-L36	GDU-B1728-31SL-L36	GDT-B1728-42SL-L36	
RECEPTACLE, ATTACHMENT 	30 / 32		GD-B1516-51SL-XX	GD-B1516-23SL-XX		GD-B1520-36SL-XX
	60 / 63		GD-B1520-61SL-XX	GD-B1520-40SL-XX	GD-B1520-56SL-XX	GD-B1524-29SL-XX
	100 / 125		GD-B1524-60SL-XX	GD-B1524-39SL-XX	GD-B1524-32SL-XX	GD-B1528-23SL-XX
	200 / 260		GDU-B1528-30SL-XX	GDU-B1528-31SL-XX	GDT-B1528-42SL-XX	
RECEPTACLE, TAPPED NPT 	30 / 32		GD-B1516-51SL-TC	GD-B1516-23SL-TC		GD-B1520-36SL-TC
	60 / 63		GD-B1520-61SL-TC	GD-B1520-40SL-TC	GD-B1520-56SL-TC	GD-B1524-29SL-TC
	100 / 125		GD-B1524-60SL-TC	GD-B1524-39SL-TC	GD-B1524-32SL-TC	GD-B1528-23SL-TC
	200 / 260		GDU-B1528-30SL-TC	GDU-B1528-31SL-TC	GDT-B1528-42SL-TC	

Replace 'XX' with cable diameter code number from Page CN66





Pre-wired lead length can be specified to suit application. Consult factory

See pages CN71 and CN77 for Part Number Code Logic

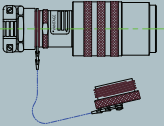
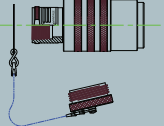

EXPLOSIONPROOF STARLINE

AF PART NUMBERS

PIN QUANTITY	PIN SIZE AWG (MM ²) 'G' = WITH GROUND PIN	AMPS @ 250 VAC ¹		PLUG, ATTACHMENT 	PLUG, TAPPED CONDUIT 	RECEPTACLE, JUNCTION BOX 
						
10	#12 (4.0)	10.0	20	AF-D1016-681PL-XX	AF-D1016-681PL-TC	AF-B1716-681SL-FH
10	#12 G (4.0)	10.0	20	AF-D1016-676PL-XX	AF-D1016-676PL-TC	AF-B1716-676SL-FH
19	#12 G (4.0)	10.0	20	AF-D1016-612PL-XX	AF-D1016-612PL-TC	AF-B1716-612SL-FH
19	#12 (4.0)	10.0	20	AF-D1016-677PL-XX	AF-D1016-677PL-TC	AF-B1716-677SL-FH
19	#12 (4.0)	10.0 1	20	AF-D1020-676PL-XX	AF-D1020-676PL-TC	AF-B1720-676SL-FH
19	#12 G (4.0)	10.0 1	20	AF-D1020-688PL-XX	AF-D1020-688PL-TC	AF-B1720-688SL-FH
19	#16 (1.5)	6.5	15	AF-D1016-655PL-XX	AF-D1016-655PL-TC	AF-B1716-655SL-FH
20	#12 (4.0)	10.0	20	AF-D1020-632PL-XX	AF-D1020-632PL-TC	AF-B1720-632SL-FH
20	#12 G (4.0)	10.0	20	AF-D1020-687PL-XX	AF-D1020-687PL-TC	AF-B1720-687SL-FH
37	#12 (4.0)	10.0	20	AF-D1020-686PL-XX	AF-D1020-686PL-TC	AF-B1720-686SL-FH
37	#12 G (4.0)	10.0	20	AF-D1020-650PL-XX	AF-D1020-650PL-TC	AF-B1720-650SL-FH
37	#16 (1.5)	6.5	15	AF-D1016-621PL-XX	AF-D1016-621PL-TC	AF-B1716-621SL-FH
55	#18 (.75)	3.5	10	AF-D1016-640PL-XX	AF-D1016-640PL-TC	AF-B1716-640SL-FH
61	#18 (.75)	3.5	10	AF-D1016-633PL-XX	AF-D1016-633PL-TC	AF-B1716-633SL-FH
68	#16 (1.5)	6.5	15	AF-D1020-613PL-XX	AF-D1020-613PL-TC	AF-B1720-613SL-FH
100	#16 (1.5)	5.0	15	AF-D1024-613PL-XX	AF-D1024-613PL-TC	AF-B1724-613SL-BK



Replace 'XX' with cable diameter code number from Page CN66
 Pre-wired lead length can be specified to suit application. Consult factory
 See pages CN73 and CN74 for Part Number Code Logic
¹ = Insert is also rated 480 VAC non-circuit breaking.

CONNECTORS

EXPLOSIONPROOF STARLINE

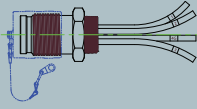
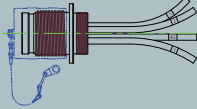
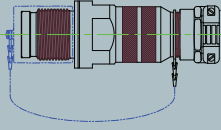

AF PART NUMBERS

PIN QUANTITY	PIN SIZE AWG (MM ²) 'G' = WITH GROUND PIN	AMPS @ 250 VAC ¹		RECEPTACLE, NPT	RECEPTACLE, PANEL MOUNT	RECEPTACLE, ATTACHMENT
						
10	#12 (4.0)	10.0	20	AF-B1916-681SL-L48	AF-B1716-681SL-L36	AF-B1516-681SL-XX
10	#12 G (4.0)	10.0	20	AF-B1916-676SL-L48	AF-B1716-676SL-L36	AF-B1516-676SL-XX
19	#12 G (4.0)	10.0	20	AF-B1916-612SL-L48	AF-B1716-612SL-L36	AF-B1516-612SL-XX
19	#12 (4.0)	10.0	20	AF-B1916-677SL-L48	AF-B1716-677SL-L36	AF-B1516-677SL-XX
19	#12 (4.0)	10.0 1	20	AF-B1920-676SL-L48	AF-B1720-676SL-L36	AF-B1520-676SL-XX
19	#12 G (4.0)	10.0 1	20	AF-B1920-688SL-L48	AF-B1720-688SL-L36	AF-B1520-688SL-XX
19	#16 (1.5)	6.5	15	AF-B1916-655SL-L48	AF-B1716-655SL-L36	AF-B1516-655SL-XX
20	#12 (4.0)	10.0	20	AF-B1920-632SL-L48	AF-B1720-632SL-L36	AF-B1520-632SL-XX
20	#12 G (4.0)	10.0	20	AF-B1920-687SL-L48	AF-B1720-687SL-L36	AF-B1520-687SL-XX
37	#12 (4.0)	10.0	20	AF-B1920-686SL-L48	AF-B1720-686SL-L36	AF-B1520-686SL-XX
37	#12 G (4.0)	10.0	20	AF-B1920-650SL-L48	AF-B1720-650SL-L36	AF-B1520-650SL-XX
37	#16 (1.5)	6.5	15	AF-B1916-621SL-L48	AF-B1716-621SL-L36	AF-B1516-621SL-XX
55	#18 (.75)	3.5	10	AF-B1916-640SL-L48	AF-B1716-640SL-L36	AF-B1516-640SL-XX
61	#18 (.75)	3.5	10	AF-B1916-633SL-L48	AF-B1716-633SL-L36	AF-B1516-633SL-XX
68	#16 (1.5)	6.5	15	AF-B1920-613SL-L48	AF-B1720-613SL-L36	AF-B1520-613SL-XX
100	#16 (1.5)	5.0	15	AF-B1924-613SL-L48	AF-B1724-613SL-L36	AF-B1524-613SL-XX

Replace 'XX' with cable diameter code number from Page CN66
 Pre-wired lead length can be specified to suit application. Consult factory
 See pages CN73 and CN74 for Part Number Code Logic
¹ = Insert is also rated 480 VAC non-circuit breaking.



EXPLOSIONPROOF STARLINE

SD PART NUMBERS

	AMPERES		2 POLE, 3 WIRE	3 POLE, 4 WIRE	3 POLE, 4 WIRE + 2 RELAY	4 POLE, 5 WIRE
PLUG, ATTACHMENT 	30 / 32		SD-D1016-51PL-XX	SD-D1016-23PL-XX		SD-D1020-36PL-XX
	60 / 63		SD-D1020-61PL-XX	SD-D1020-40PL-XX	SD-D1020-56PL-XX	SD-D1024-29PL-XX
	100 / 125		SD-D1024-60PL-XX	SD-D1024-39PL-XX	SD-D1024-32PL-XX	SD-D1028-23PL-XX
	200 / 260		SDU-D1028-30PL-XX	SDU-D1028-31PL-XX	SDT-D1028-42PL-XX	
PLUG, TAPPED NPT 	30 / 32		SD-D1016-51PL-TC	SD-D1016-23PL-TC		SD-D1020-36PL-TC
	60 / 63		SD-D1020-61PL-TC	SD-D1020-40PL-TC	SD-D1020-56PL-TC	SD-D1024-29PL-TC
	100 / 125		SD-D1024-60PL-TC	SD-D1024-39PL-TC	SD-D1024-32PL-TC	SD-D1028-23PL-TC
	200 / 260		SDU-D1028-30PL-TC	SDU-D1028-31PL-TC	SDT-D1028-42PL-TC	
RECEPTACLE, JUNCTION BOX 	30 / 32		SD-B1716-51SL-FH	SD-B1716-23SL-FH		SD-B1720-36SL-FH
	60 / 63		SD-B1720-61SL-FH	SD-B1720-40SL-FH	SD-B1720-56SL-FH	SD-B1724-29SL-BK
	100 / 125		SD-B1724-60SL-BK	SD-B1724-39SL-BK	SD-B1724-32SL-BK	SD-B1728-23SL-BL
	200 / 260		SDU-B1728-30SL-BL	SDU-B1728-31SL-BL	SDT-B1728-42SL-BL	
RECEPTACLE, NPT 	30 / 32		SD-B1916-51SL-L48	SD-B1916-23SL-L48		SD-B1920-36SL-L48
	60 / 63		SD-B1920-61SL-L48	SD-B1920-40SL-L48	SD-B1920-56SL-L48	SD-B1924-29SL-L48
	100 / 125		SD-B1924-60SL-L48	SD-B1924-39SL-L48	SD-B1924-32SL-L48	SD-B1928-23SL-L48
	200 / 260		SDU-B1928-30SL-L48	SDU-B1928-31SL-L48	SDT-B1928-42SL-L48	
RECEPTACLE, PANEL MOUNT 	30 / 32		SD-B1716-51SL-L36	SD-B1716-23SL-L36		SD-B1720-36SL-L36
	60 / 63		SD-B1720-61SL-L36	SD-B1720-40SL-L36	SD-B1720-56SL-L36	SD-B1724-29SL-L36
	100 / 125		SD-B1724-60SL-L36	SD-B1724-39SL-L36	SD-B1724-32SL-L36	SD-B1728-23SL-L36
	200 / 260		SDU-B1728-30SL-L36	SDU-B1728-31SL-L36	SDT-B1728-42SL-L36	
RECEPTACLE, ATTACHMENT 	30 / 32		SD-B1516-51SL-XX	SD-B1516-23SL-XX		SD-B1520-36SL-XX
	60 / 63		SD-B1520-61SL-XX	SD-B1520-40SL-XX	SD-B1520-56SL-XX	SD-B1524-29SL-XX
	100 / 125		SD-B1524-60SL-XX	SD-B1524-39SL-XX	SD-B1524-32SL-XX	SD-B1528-23SL-XX
	200 / 260		SDU-B1528-30SL-XX	SDU-B1528-31SL-XX	SDT-B1528-42SL-XX	
RECEPTACLE, TAPPED NPT 	30 / 32		SD-B1516-51SL-TC	SD-B1516-23SL-TC		SD-B1520-36SL-TC
	60 / 63		SD-B1520-61SL-TC	SD-B1520-40SL-TC	SD-B1520-56SL-TC	SD-B1524-29SL-TC
	100 / 125		SD-B1524-60SL-TC	SD-B1524-39SL-TC	SD-B1524-32SL-TC	SD-B1528-23SL-TC
	200 / 260		SDU-B1528-30SL-TC	SDU-B1528-31SL-TC	SDT-B1528-42SL-TC	

Replace 'XX' with cable diameter code number from Page CN66

Pre-wired lead length can be specified to suit application. Consult factory





See pages CN71 and CN72 for Part Number Code Logic

CONNECTORS

EXPLOSIONPROOF STARLINE

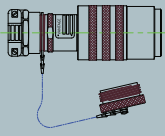
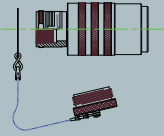

SF PART NUMBERS



PIN QUANTITY	PIN SIZE AWG (MM ²) 'G' = WITH GROUND PIN	AMPS @ 250 VAC ¹		PLUG, ATTACHMENT	PLUG, TAPPED CONDUIT	RECEPTACLE, JUNCTION BOX
						
10	#12 (4.0)	10.0	20	SF-D1016-681PL-XX	SF-D1016-681PL-TC	SF-B1716-681SL-FH
10	#12 G (4.0)	10.0	20	SF-D1016-676PL-XX	SF-D1016-676PL-TC	SF-B1716-676SL-FH
19	#12 G (4.0)	10.0	20	SF-D1016-612PL-XX	SF-D1016-612PL-TC	SF-B1716-612SL-FH
19	#12 (4.0)	10.0	20	SF-D1016-677PL-XX	SF-D1016-677PL-TC	SF-B1716-677SL-FH
19	#12 (4.0)	10.0 1	20	SF-D1020-676PL-XX	SF-D1020-676PL-TC	SF-B1720-676SL-FH
19	#12 G (4.0)	10.0 1	20	SF-D1020-688PL-XX	SF-D1020-688PL-TC	SF-B1720-688SL-FH
19	#16 (1.5)	6.5	15	SF-D1016-655PL-XX	SF-D1016-655PL-TC	SF-B1716-655SL-FH
20	#12 (4.0)	10.0	20	SF-D1020-632PL-XX	SF-D1020-632PL-TC	SF-B1720-632SL-FH
20	#12 G (4.0)	10.0	20	SF-D1020-687PL-XX	SF-D1020-687PL-TC	SF-B1720-687SL-FH
37	#12 (4.0)	10.0	20	SF-D1020-686PL-XX	SF-D1020-686PL-TC	SF-B1720-686SL-FH
37	#12 G (4.0)	10.0	20	SF-D1020-650PL-XX	SF-D1020-650PL-TC	SF-B1720-650SL-FH
37	#16 (1.5)	6.5	15	SF-D1016-621PL-XX	SF-D1016-621PL-TC	SF-B1716-621SL-FH
55	#18 (.75)	3.5	10	SF-D1016-640PL-XX	SF-D1016-640PL-TC	SF-B1716-640SL-FH
61	#18 (.75)	3.5	10	SF-D1016-633PL-XX	SF-D1016-633PL-TC	SF-B1716-633SL-FH
68	#16 (1.5)	6.5	15	SF-D1020-613PL-XX	SF-D1020-613PL-TC	SF-B1720-613SL-FH
100	#16 (1.5)	5.0	15	SF-D1024-613PL-XX	SF-D1024-613PL-TC	SF-B1724-613SL-BK

Replace 'XX' with cable diameter code number from Page CN66
 Pre-wired lead length can be specified to suit application. Consult factory
 See pages CN73 and CN74 for Part Number Code Logic
¹ = Insert is also rated 480 VAC non-circuit breaking.



EXPLOSIONPROOF STARLINE

SF PART NUMBERS CONTINUED

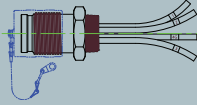
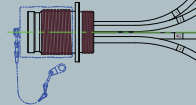
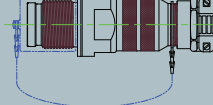
PIN QUANTITY	PIN SIZE AWG (MM ²) 'G' = WITH GROUND PIN	AMPS @ 250 VAC ¹		RECEPTACLE, NPT	RECEPTACLE, PANEL MOUNT	RECEPTACLE, ATTACHMENT
						
10	#12 (4.0)	10.0	20	SF-B1916-681SL-L48	SF-B1716-681SL-L36	SF-B1516-681SL-XX
10	#12 G (4.0)	10.0	20	SF-B1916-676SL-L48	SF-B1716-676SL-L36	SF-B1516-676SL-XX
19	#12 G (4.0)	10.0	20	SF-B1916-612SL-L48	SF-B1716-612SL-L36	SF-B1516-612SL-XX
19	#12 (4.0)	10.0	20	SF-B1916-677SL-L48	SF-B1716-677SL-L36	SF-B1516-677SL-XX
19	#12 (4.0)	10.01	20	SF-B1920-676SL-L48	SF-B1720-676SL-L36	SF-B1520-676SL-XX
19	#12 G (4.0)	10.01	20	SF-B1920-688SL-L48	SF-B1720-688SL-L36	SF-B1520-688SL-XX
19	#16 (1.5)	6.5	15	SF-B1916-655SL-L48	SF-B1716-655SL-L36	SF-B1516-655SL-XX
20	#12 (4.0)	10.0	20	SF-B1920-632SL-L48	SF-B1720-632SL-L36	SF-B1520-632SL-XX
20	#12 G (4.0)	10.0	20	SF-B1920-687SL-L48	SF-B1720-687SL-L36	SF-B1520-687SL-XX
37	#12 (4.0)	10.0	20	SF-B1920-686SL-L48	SF-B1720-686SL-L36	SF-B1520-686SL-XX
37	#12 G (4.0)	10.0	20	SF-B1920-650SL-L48	SF-B1720-650SL-L36	SF-B1520-650SL-XX
37	#16 (1.5)	6.5	15	SF-B1916-621SL-L48	SF-B1716-621SL-L36	SF-B1516-621SL-XX
55	#18 (.75)	3.5	10	SF-B1916-640SL-L48	SF-B1716-640SL-L36	SF-B1516-640SL-XX
61	#18 (.75)	3.5	10	SF-B1916-633SL-L48	SF-B1716-633SL-L36	SF-B1516-633SL-XX
68	#16 (1.5)	6.5	15	SF-B1920-613SL-L48	SF-B1720-613SL-L36	SF-B1520-613SL-XX
100	#16 (1.5)	5.0	15	SF-B1924-613SL-L48	SF-B1724-613SL-L36	SF-B1524-613SL-XX

Replace 'XX' with cable diameter code number from Page CN66
 Pre-wired lead length can be specified to suit application. Consult factory
 See pages CN73 and CN74 for Part Number Code Logic
¹' = Insert is also rated 480 VAC non-circuit breaking.

XP STARLINE DIMENSIONS

	SHELL SIZE	A INCHES ±0.3 (MM ±8)	B INCHES ±0.3 (MM ±8)	C INCHES (MM)	D INCHES ±0.3 (MM ±8)	E INCHES (MM)	WEIGHT¹ LBS (KG)
AF/SF GD/SD BM Stainless Steel Weight Factor 2.0	16	9.3 (236)	10.3 (262)	2.977 (75.6)	8.4 (213)	3.75 - 10.25 (95 - 260)	4.0 (1.8)
	20	10.0 (254)	11.0 (279)	3.577 (90.9)	9.0 (229)	5.75 - 14.25 (146 - 362)	5.2 (2.4)
	24	10.4 (264)	11.4 (290)	4.182 (106.2)	9.4 (239)	8.25 - 17.25 (210 - 438)	7.2 (3.3)
	28	10.9 (277)	11.9 (302)	4.814 (122.3)	9.8 (249)	13.75 - 19.75 (349 - 502)	9.1 (4.1)
GB/SB GDU/SDU Stainless Steel Weight Factor 2.0	16	10.3 (262)	11.3 (287)	2.977 (75.6)	9.4 (238)	3.75 - 10.25 (95 - 260)	3.9 (1.8)
	20	11.0 (279)	12.0 (305)	3.577 (90.9)	10.0 (254)	5.75 - 14.25 (146 - 362)	6.0 (2.7)
	24	11.4 (290)	12.4 (315)	4.182 (106.2)	10.4 (264)	8.25 - 17.25 (210 - 438)	8.4 (3.8)
	28	11.9 (302)	12.9 (328)	4.814 (122.3)	10.8 (274)	13.75 - 19.75 (349 - 502)	12.1 (5.5)

Attachment Plug

1. Weights provided for Victory Series (aluminum) with mechanical clamp configuration. Multiply by "Stainless Steel Weight Factor" to determine weight for Millennium Series (stainless steel).

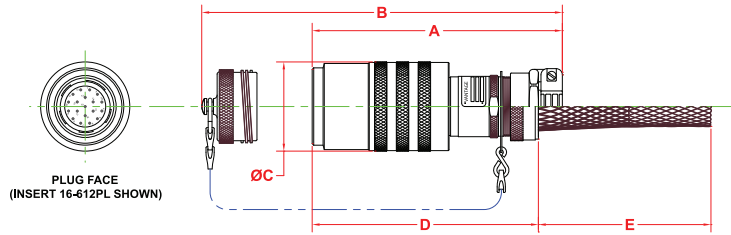

	SHELL SIZE	F INCHES (MM)	G INCHES (MM)	H INCHES (MM)	NPT THREAD 'J'	WEIGHT¹ LBS (KG)	WEIGHT¹ LBS (KG)
AF/SF GD/SD BM Stainless Steel Weight Factor 2.4	16	7.9 (200)	6.9 (175)	2.977 (75.6)	1 ¼ - 11 ½	2.9 (1.3)	4.0 (1.8)
	20	8.2 (208)	7.2 (183)	3.577 (90.9)	1 ½ - 11 ½	4.0 (1.8)	5.2 (2.4)
	24	8.4 (213)	7.4 (188)	4.182 (106.2)	2 - 11 ½	5.4 (2.5)	7.2 (3.3)
	28	8.8 (224)	7.8 (198)	4.814 (122.3)	2 ½ - 8	7.2 (3.3)	9.1 (4.1)
GB/SB GDU/SDU Stainless Steel Weight Factor 2.4	16	8.9 (226)	7.9 (201)	2.977 (75.6)	1 ¼ - 11 ½	3.4 (1.5)	3.9 (1.8)
	20	9.2 (234)	8.2 (208)	3.577 (90.9)	1 ½ - 11 ½	5.0 (2.3)	6.0 (2.7)
	24	9.4 (239)	8.4 (213)	4.182 (106.2)	2 - 11 ½	7.4 (3.4)	8.4 (3.8)
	28	9.8 (249)	8.8 (224)	4.814 (122.3)	2 ½ - 8	9.5 (4.3)	12.1 (5.5)

NPT Tapped Plug

1. Weights provided for Victory Series (aluminum). Multiply by "Stainless Steel Weight Factor" to determine weight for Millennium Series (stainless steel).

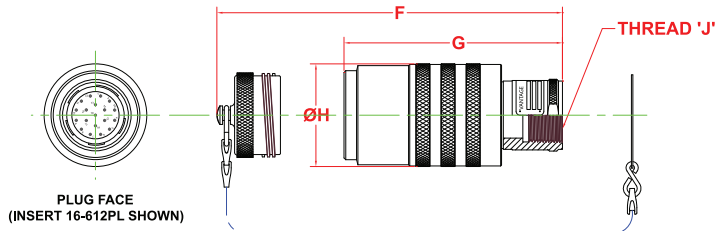

	SHELL SIZE	K INCHES ±0.3 (MM ±8)	L INCHES ±0.3 (MM ±8)	M INCHES (MM)	N INCHES (MM)	P INCHES (MM)	WEIGHT¹ LBS (KG)
AF/SF GD/SD BM Stainless Steel Weight Factor 2.0	16	10.0 (254)	9.1 (231)	3.75 - 10.25 (95 - 260)	1.969 (50.1)	3.063 (77.8)	3.4 (1.5)
	20	10.7 (272)	9.7 (246)	5.75 - 14.25 (146 - 362)	2.469 (62.7)	3.563 (90.5)	4.7 (2.1)
	24	11.1 (282)	10.1 (257)	8.25 - 17.25 (210 - 438)	2.969 (75.4)	4.188 (106.4)	6.4 (2.9)
	28	11.4 (290)	10.3 (262)	13.75 - 19.75 (349 - 502)	3.469 (88.1)	4.688 (119.1)	8.1 (3.7)
GB/SB GDU/SDU Stainless Steel Weight Factor 2.0	16	11.0 (279)	10.1 (257)	3.75 - 10.25 (95 - 260)	1.969 (50.1)	3.063 (77.8)	3.6 (1.6)
	20	11.7 (297)	10.7 (272)	5.75 - 14.25 (146 - 362)	2.469 (62.7)	3.563 (90.5)	4.9 (2.2)
	24	12.1 (307)	11.1 (282)	8.25 - 17.25 (210 - 438)	2.969 (75.4)	4.188 (106.4)	6.7 (3.0)
	28	12.4 (315)	11.3 (287)	13.75 - 19.75 (349 - 502)	3.469 (88.1)	4.688 (119.1)	8.6 (3.9)

Attachment Receptacle

1. Weights provided for Victory Series (aluminum) with mechanical clamp configuration. Multiply by "Stainless Steel Weight Factor" to determine weight for Millennium Series (stainless steel).

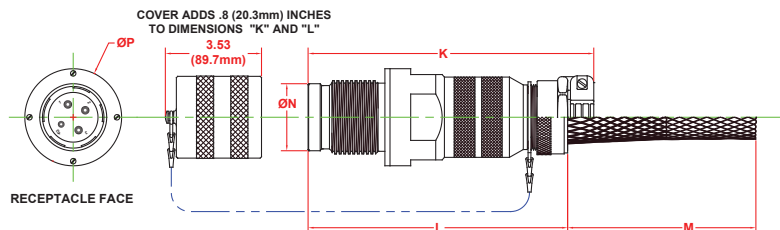



EXPLOSIONPROOF STARLINE

XP STARLINE DIMENSIONS

	SHELL SIZE	A INCHES ¹ (MM)	B INCHES ¹ (MM)	C INCHES (MM)	D INCHES (MM)	THREAD 'E' G-16UN	WEIGHT ² LBS (KG)
AF/SF GD/SD BM Stainless Steel Weight Factor 2.0	16	4.063 (103.2)	3.063 (77.8)	1.969 (50.0)	3.063 (77.8)	2	3 (1.4)
	20	4.063 (103.2)	3.063 (77.8)	2.469 (62.7)	3.563 (90.5)	2 ½	4 (1.8)
	24	4.063 (103.2)	3.063 (77.8)	2.969 (75.4)	4.188 (106.4)	3 1/8	8 (3.6)
	28	4.063 (103.2)	3.063 (77.8)	3.469 (88.1)	4.688 (119.1)	3 5/8	13 (5.9)
GB/SB GDU/SDU Stainless Steel Weight Factor 2.0	16	5.063 (128.6)	4.063 (103.2)	1.969 (50.0)	3.063 (77.8)	2	3 (1.4)
	20	5.063 (128.6)	4.063 (103.2)	2.469 (62.7)	3.563 (90.5)	2 ½	5 (2.3)
	24	5.063 (128.6)	4.063 (103.2)	2.969 (75.4)	4.188 (106.4)	3 1/8	8 (3.6)
	28	5.063 (128.6)	4.063 (103.2)	3.469 (88.1)	4.688 (119.1)	3 5/8	14 (6.4)

Panel Mount Receptacle

1. Subtract 0.5 inches (12.7mm) from dimensions A and B for AF/SF style.
2. Weights provided for Victory Series (aluminum). Multiply by "Stainless Steel Weight Factor" to determine weight for Millennium Series (stainless steel).

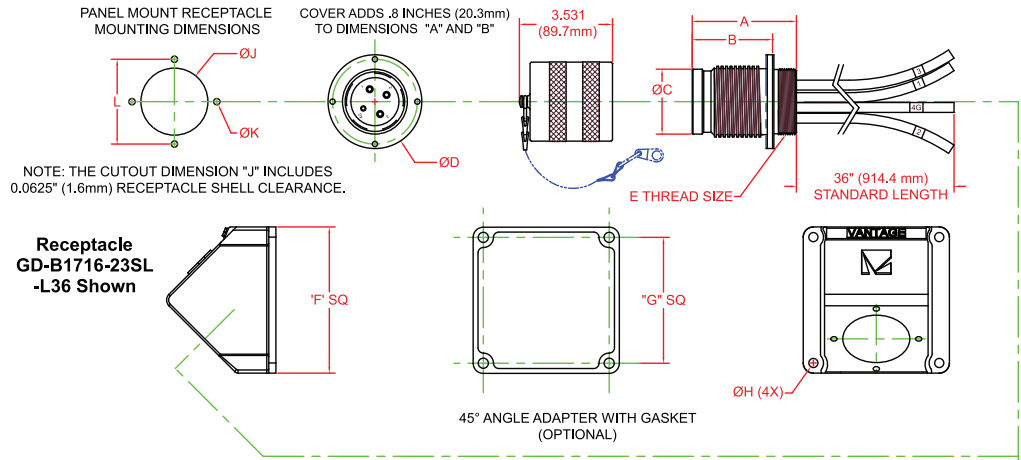

MOUNTING DIMENSIONS

SHELL SIZE	F INCHES (MM)	G INCHES (MM)	H INCHES (MM)	J INCHES (MM)	K INCHES (MM)	L INCHES (MM)
16	4.5 (114.3)	3.875 (98.4)	0.284 (7.2)	2.063 (52.4)	0.195 (5.0)	2.610 (66.3)
20	4.5 (114.3)	3.875 (98.4)	0.284 (7.2)	2.563 (65.1)	0.195 (5.0)	3.110 (79.0)
24	8 (203.2)	7 (177.8)	0.534 (13.6)	3.063 (77.8)	0.195 (5.0)	3.735 (94.9)
28	8 (203.2)	7 (177.8)	0.534 (13.6)	3.563 (90.5)	0.195 (5.0)	4.235 (107.6)

	SHELL SIZE	M INCHES (MM)	N INCHES (MM)	P INCHES ¹ (MM)	Q INCHES ¹ (MM)	NPT THREAD 'R'	S INCHES (MM)	WEIGHT LBS ² (KG)
AF/SF GD/SD BM Stainless Steel Weight Factor 2.0	16	2.5 (63.5)	2.875 (73.0)	4.5 (114.3)	3.656 (92.9)	1 ½ - 11 ½	1.969 (50.0)	3 (1.4)
	20	3 (76.2)	3.469 (88.1)	4.531 (115.1)	3.656 (92.9)	2 - 11 ½	2.469 (62.7)	5 (2.3)
	24	3.5 (88.9)	4.031 (102.4)	4.906 (124.6)	3.656 (92.9)	2 ½ - 8	2.969 (75.4)	8 (3.6)
	28	4 (101.6)	4.625 (117.5)	4.969 (126.2)	3.656 (92.9)	3 - 8	3.469 (88.1)	13 (5.9)
GB/SB GDU/SDU Stainless Steel Weight Factor 2.0	16	2.5 (63.5)	2.875 (73.0)	5 (127.0)	4.156 (105.6)	1 ½ - 11 ½	1.969 (50.0)	3 (1.4)
	20	3 (76.2)	3.469 (88.1)	5.031 (127.8)	4.156 (105.6)	2 - 11 ½	2.469 (62.7)	5 (2.3)
	24	3.5 (88.9)	4.031 (102.4)	5.406 (137.3)	4.156 (105.6)	2 ½ - 8	2.969 (75.4)	9 (4.1)
	28	4 (101.6)	4.625 (117.5)	5.469 (138.9)	4.156 (105.6)	3 - 8	3.469 (88.1)	14 (6.4)

NPT Mount Receptacle

1. Subtract 0.5 inches (12.7mm) from dimensions P and Q for AF/SF style.
2. Weights provided for Victory Series (aluminum). Multiply by "Stainless Steel Weight Factor" to determine weight for Millennium Series (stainless steel).

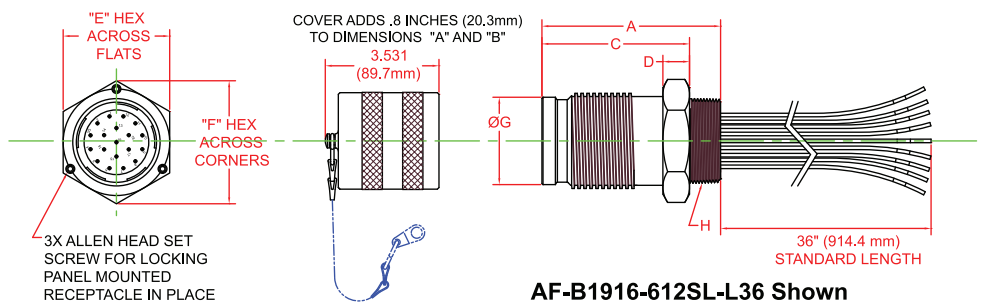

CONNECTORS

EXPLOSIONPROOF STARLINE



XP STARLINE DIMENSIONS

	SHELL SIZE	A INCHES (MM)	B INCHES (MM)	C INCHES (MM)	D INCHES (MM)	WEIGHT LBS ¹ (KG)
AF/SF GD/SD BM Stainless Steel Weight Factor 2.0	16	10.063 (255.6)	10.25 (260.4)	7.375 (187.3)	7.75 (196.9)	12.9 (5.9)
	20	10.063 (255.6)	10.25 (260.4)	7.375 (187.3)	7.75 (196.9)	13.7 (6.2)
	24	14.563 (370.0)	14 (355.6)	9.688 (246.1)	10.125 (257.2)	21.9 (9.9)
	28	14.563 (370.0)	14 (355.6)	9.688 (246.1)	10.125 (257.2)	22.8 (10.3)
GB/SB GDU/SDU Stainless Steel Weight Factor 2.0	16	11.563 (293.7)	11.125 (282.6)	7.875 (200.0)	8.25 (209.6)	13.0 (5.9)
	20	11.563 (293.7)	11.125 (282.6)	7.875 (200.0)	8.25 (209.6)	13.9 (6.3)
	24	15.438 (392.1)	14.875 (377.8)	10.188 (258.8)	10.625 (269.9)	22.5 (10.2)
	28	15.438 (392.1)	14.875 (377.8)	10.188 (258.8)	10.625 (269.9)	23.2 (10.5)

1. Weights provided for Victory Series (aluminum). Multiply by "Stainless Steel Weight Factor" to determine weight for Millennium Series (stainless steel).

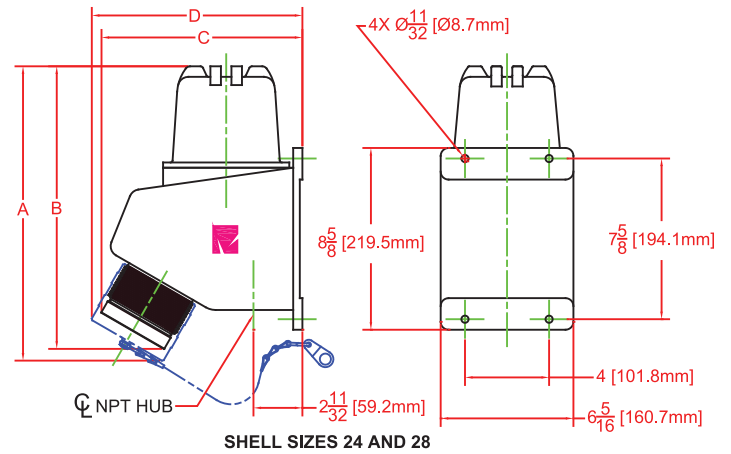
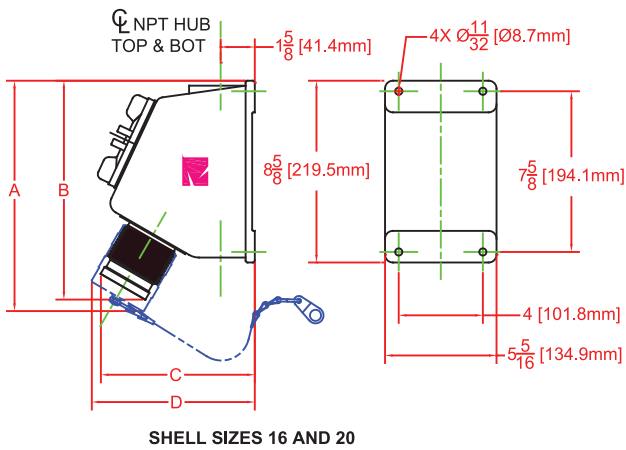



EXPLOSIONPROOF STARLINE

FEATURES • GROUND POWER & AIRCRAFT CONNECTORS



Ratings & Certifications:

Class I, Groups C & D. 480VAC, 60/400 Hz, Circuit-Breaking.

Class I, Groups B, C & D and Class II, Groups F & G
600VAC, 60/400 Hz, Circuit-Breaking.

II 2 G D, Ex d IIB + H2 IP66/67
T70 KEMA04ATEX2179X 50/60/400 Hz;
1000VAC, 500VDC

Hangar Ground Power Receptacle

Vantage Ground Power receptacles mount flush into the concrete deck of an aircraft hangar or service apron. Cast from nodular iron for increased strength and durability, each unit is available with one or two power receptacles mounted in the intermediate cover. Power receptacles are rated at 30, 60, 100 or 200 amps at 50/60/400 Hz.

- Single or duplex receptacle combinations available
- Explosionproof pushbuttons and pilot lights for point-of-use control.
- Color coded covers and conduit entries to customer specifications.
- Unique drainage system prevents pooling around the receptacle.



ADDITIONAL CONNECTORS FOR THE AIRCRAFT INDUSTRY

Receptacles for Hangar Service Pits

Hangar pits and service outlets allow military and commercial airline operators to position electrical power in the hangar floor convenient to aircraft scheduled for maintenance. Equipped with power and/or control circuits, maintenance crews can easily use the pit receptacle to hook up portable equipment or bring power directly to the aircraft.

Receptacles for Aircraft Test Stands:

Test stands for the 767 and C5A airplanes require 30 amp, 480 VAC, 4 pole 5 wire explosion proof connectors. Panel Mount style receptacles are used to safely bring power to and from various test stand enclosures. Supplied with a flat gasket to maintain the purge within the enclosure, Panel Mount receptacles are also pre-wired and factory sealed, requiring no external seal fittings. Optional color coding and alternate keyed inserts ensure proper mating.

Receptacles for Hangar Bulkhead Mounting & Aircraft Cable Assemblies

Vantage connectors safely make and break under full rated load in the presence of jet fuel vapor and other hazardous gases. GDT connectors come complete with E & F relay pins for electrical interlock and are ideal for high ampere hangar applications rated Class I, Division 1. We combine Vantage explosionproof connectors and MS rubber-molded connectors to fabricate 400Hz Ground Support assemblies. Utilizing the E and F relay pins to create an electrical interlock, these flexible assemblies supply power directly to aircraft, mobile carts and frequency converters.



PART NUMBERS GROUND POWER

Receptacle, Ground Power

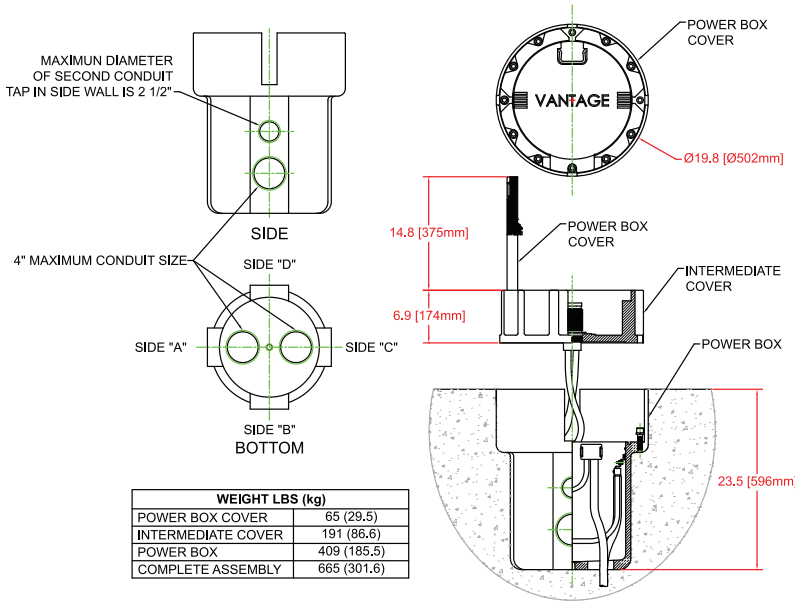

AMPS	INSERT		INSERT SYMBOL	RECEPTACLE ASSEMBLY
	600/1000 VAC, 60/400 HZ			
30	32	2 Pole 3 Wire	A1	GD-1716-51SL-L36
		3 Pole 4 Wire	A2	GD-1716-23SL-L36
		4 Pole 5 Wire	B1	GD-1720-36SL-L36
60	63	2 Pole 3 Wire	B2	GD-1720-61SL-L36
		3 Pole 4 Wire	B3	GD-1720-40SL-L36
		4 Pole 5 Wire	C1	GD-1724-29SL-L36
100	125	2 Pole 3 Wire	C2	GD-1724-60SL-L36
		3 Pole 4 Wire	C3	GD-1724-39SL-L36
		4 Pole 5 Wire	D1	GD-1728-23SL-L36
200	260	2 Pole 3 Wire	D3	GD-1728-30SL-L36
		3 Pole 4 Wire	D4	GD-1728-31SL-L36
		5 Pole 6 Wire	D5	GDT-1728-42SL-L36

SINGLE RECEPTACLE

GDS - D5L1 - 92ANMEQP

Of the many available variations we selected above example:

- GD = Class I, Division 1, Groups C-D;
- S = Red/Amber pilot lights and on/off switches;
- D5L1 = 200/260 amp, 5P 6W, 60/400 hertz keyed in the 01 position;
- 92 = single;
- ANM = Side A - 3.0" and 2.5";
- EQP = Side E - 4.0" and 3.5".

For additional part numbers see Single code logic on page CN75.
Mating plugs are listed on page CN47.

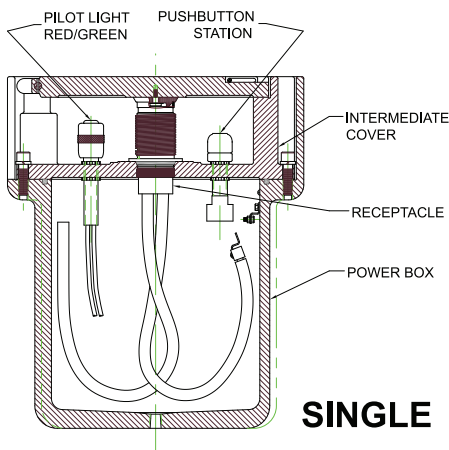

DUPLEX RECEPTACLE

GD - A1B3 - 93B68DMN

There are hundreds of variations and we selected the above example:

- GD = Class I, Division 1, Groups C-D;
- A1 = 30/32 amp, 2P 3W, 60/400 hertz;
- B3 = 60/63 amp, 3P 4W, 60/400 hertz;
- 93 = duplex;
- B68 = Side B - 1.0" and 1.5";
- DMN = Side D - 2.5" and 3.0".

For additional part numbers see Duplex code logic on page CN76.
Mating plugs are listed on page CN47.

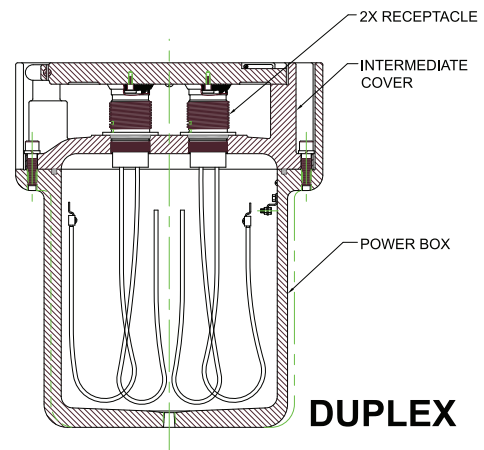



EXPLOSIONPROOF STARLINE

CODE LOGIC – GROUND POWER, SINGLE

SINGLE

GD	S	-	D5	L	1	-	92	A	N	M	E	Q	P
1	2		3	4	5		6	7	8	9	10	11	12

- 1. Classification GD = Class I, Groups B-C-D, 600 VAC, 60/400 Hz Ex d IIC T6 IP 66/67 T70°, 1000 VAC / 500 VDC
- 2. Controls
 Omit if Not Required
 R = 1 red pilot + 1 push button switch
 S = 1 red and 1 amber pilot light + 2 push button switches
 P = red and 1 green pilot light + 2 push button switches
- 3. Receptacle D5 = See Receptacle Table
- 4. Contact L = Crimp Type, Silver-plated / Standard
- 5. Insert Keying Omit for normal (N) key - See Receptacle Table
- 6. Box Style 92 = Single Receptacle
- 7. NPT Location Side A, B, C, D or E - See Conduit Location Drawing
- 8. NPT Size #1 Select from Code Symbol Table
- 9. NPT Size #2 Select from Code Symbol Table - Omit if Not Required
- 10. (11 and 12) Same as 7, 8, and 9 - If Required

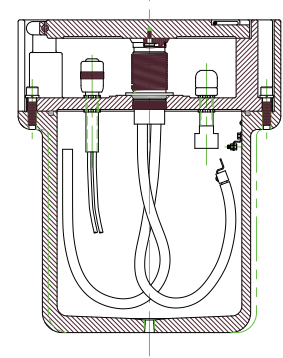

RECEPTACLE TABLE					
AMPS		INSERT	INSERT SYMBOL	RECEPTACLE ASSEMBLY	KEY POSITIONS ¹
UL	CS				
30	32	2 POLE, 3 WIRE	A1	GD-1716-51SL-L36	N + 5
		3 POLE, 4 WIRE	A2	GD-1716-23SL-L36	N + 5
		4 POLE, 5 WIRE	B1	GD-1720-36SL-L36	N + 2
60	63	2 POLE, 3 WIRE	B2	GD-1720-61SL-L36	N + 7
		3 POLE, 4 WIRE	B3	GD-1720-40SL-L36	N + 4
		4 POLE, 5 WIRE	C1	GD-1724-29SL-L36	N + 3
100	125	2 POLE, 3 WIRE	C2	GD-1724-60SL-L36	N + 7
		3 POLE, 4 WIRE	C3	GD-1724-39SL-L36	N + 5
		4 POLE, 5 WIRE	D1	GD-1728-23SL-L36	N + 3
200	260	2 POLE, 3 WIRE	D3	GD-1728-30SL-L36	N + 9
		3 POLE, 4 WIRE	D4	GDU-1728-31SL-L36	N + 3
		5 POLE, 6 WIRE (3P, 4W, 2 #10 relay contacts)	D5	GDT-1728-42SL-L36	N + 10

1. NORMAL KEY POSITION = N; ALTERNATE KEYS = 01, 02, ETC.

CODE SYMBOLS – NPT	
SYMBOL	NPT SIZE
4	1/2"
5	3/4"
6	1"
7	1 1/4"
8	1 1/2"
9	2"
M	2 1/2"
N	3"
P	3 1/2"
Q	4"

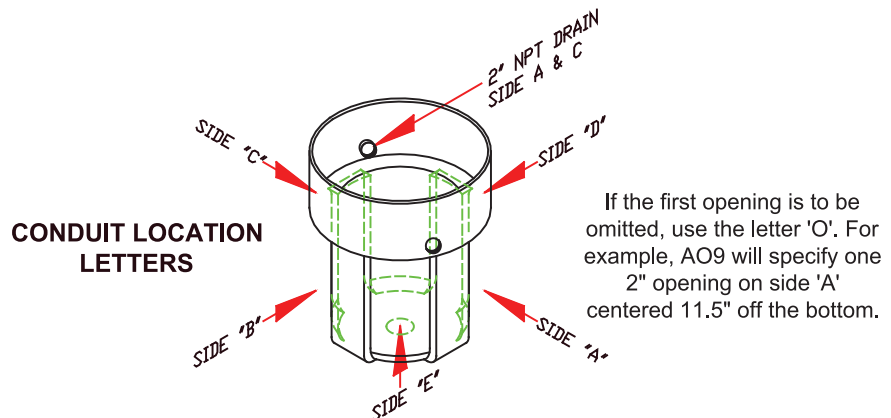

CONNECTORS

EXPLOSIONPROOF STARLINE



CODE LOGIC – GROUND POWER, DUPLEX

DUPLEX

GD	-	A1	B3	L	1	2	-	93	B	6	8	D	7	M
1		2	3	4	5	6		7	8	9	10	11	12	13

- 1. **Classification** GD = Class I, Groups C-D, 600 VAC, 60/400 Hertz Ex d IIC T6 IP 66/67 T70°, 1000 VAC / 500 VDC
- 2. **Receptacle #1** A1 = See Receptacle Table
- 3. **Receptacle #2** B3 = See Receptacle Table
- 4. **Contact** L = Crimp Type, Silver-plated / Standard
- 5. **Insert Keying #1** Omit for normal (N) key - See Receptacle Table
- 6. **Insert Keying #2** Omit for normal (N) key - See Receptacle Table
- 7. **Box Size** 93 = Duplex Receptacle
- 8. **NPT Location** Side A, B, C, D or E - See Conduit Location Drawing
- 9. **NPT Size #1** Select from Code Symbol Table
- 10. **NPT Size #2** Select from Code Symbol Table - Omit if Not Required
- 11. **(12 and 13)** Same as 8, 9, and 10 - If Required

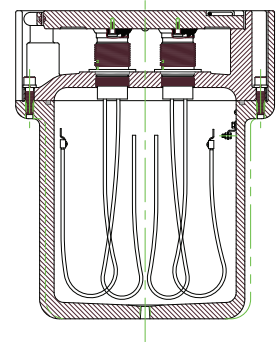

RECEPTACLE TABLE					
AMPS		INSERT	INSERT SYMBOL	RECEPTACLE ASSEMBLY	KEY POSITIONS ¹
UL _C SB _{US}	Ex				
30	32	2 POLE, 3 WIRE	A1	GD-1716-51SL-L36	N + 7
		3 POLE, 4 WIRE	A2	GD-1716-23SL-L36	N + 5
		4 POLE, 5 WIRE	B1	GD-1720-36SL-L36	N + 2
60	63	2 POLE, 3 WIRE	B2	GD-1720-61SL-L36	N + 7
		3 POLE, 4 WIRE	B3	GD-1720-40SL-L36	N + 4

1. NORMAL KEY POSITION = N; ALTERNATE KEYS = 01, 02, ETC.

CODE SYMBOLS – NPT	
SYMBOL	NPT SIZE
4	½"
5	¾"
6	1"
7	1 ¼"
8	1 ½"
9	2"
M	2 ½"
N	3"
P	3 ½"
Q	4"

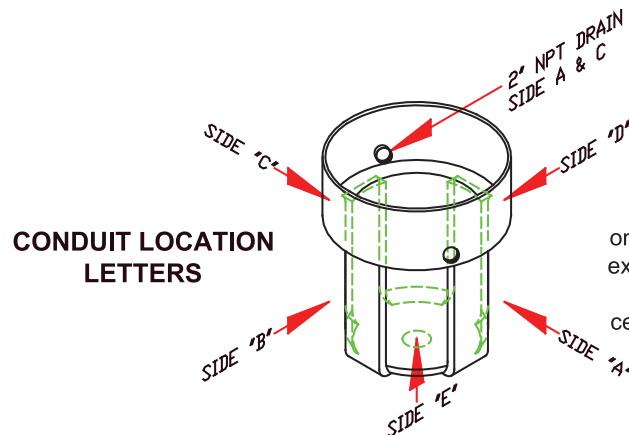

If the first opening is to be omitted, use the letter 'O'. For example, AO9 will specify one 2" opening on side 'A' centered 11.5" off the bottom.

Note: Code logic is provided to identify features called out by standard part numbers. Not all component codes are compatible with all others. Reference part number tables under appropriate product sections of this catalog or consult Vantage Technology.



XP STARLINE INSERT AND CONTACT FEATURES

Inserts

Vantage inserts come in power (30 thru 260 AMP) and control (10 thru 100 contacts) versions. Within these power and control versions many options are available. See depictions of inserts for electrical ratings, certifications and available key positions. Inserts are designed for simplified field termination. Power inserts feature captive contacts that utilize pressure termination. Control inserts utilize crimp contacts that are rear insertable, rear removable. Consult factory for replacements.

Grounding

Power inserts feature ground contacts which provide shell grounding, polarization, and make-first, break last function. Many control inserts feature ground contacts which provide shell grounding and make-first, break last function.

Relay Circuits

Some inserts are available with a pair of relay contacts that are shorter than all other contacts to provide a time delay during breaking and making.

**POWER CONTACTS
PRESSURE TERMINATION, NON-REMOVABLE**

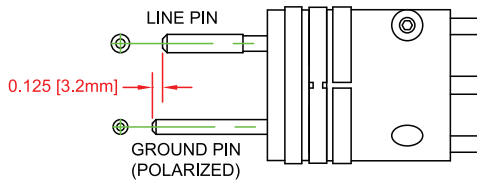

**CONTROL CONTACTS
CRIMP TERMINATION, REAR INSERTABLE - REAR REMOVABLE**

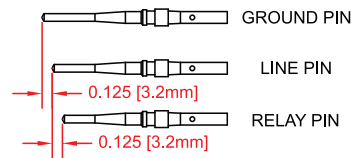

Plating Options

Control contacts come standard with silver plating. Gold plating is available for added corrosion resistance. The following plating options are available.

SYMBOL	FINISH
L	Silver
K	Gold over Silver
D	Gold over Nickel

Ferrules

Ferrules are designed to serve as a compression supporting member when an undersized wire is crimp terminated into a larger contact. Ferrules are gold plated.



PART NUMBER	CONTACT SIZE AWG (MM ²) PIN OR SOCKET		
	10 (6)	12 (4)	16 (1.5)
FERRULE SIZE			
VT-70065-1012K	12		
VT-70065-1014K	14		
VT-70065-1016K	16		
VT-70065-1216K		16	
VT-70065-1218K		18	
VT-70065-1220K		20	
VT-70065-1620K			20
VT-70065-1622K			22

Example: To transition From #12 contact to #20 wire, use V-70065-1220K.

Thermocouple Contacts

AF / SF inserts with 16 AWG contacts can be ordered with thermocouple contacts.

PART NUMBER/GENDER	ISA SYMBOL	THERMOCOUPLE MATERIAL	ISA COLOR CODING			TEMPERATURE RANGE	
			(+)	(-)	JACKET	DEGREES CONTINUOUS	SHORT TIME
VT-4016-50MF / PIN	J	Iron	White	Red	Black	0-1100° C	to 1100° C
VT-4116-50MF / SOCKET	J						
VT-4016-50NF / PIN	J	Constantan	Yellow	Red	Yellow	0-1100° C	to 1350° C
VT-4116-50NF / SOCKET	J						
VT-4016-50PO / PIN	K	Chromel	Yellow	Red	Yellow	0-1100° C	to 1350° C
VT-4116-50PO / SOCKET	K						
VT-4016-50RO / PIN	K	Alumel	Yellow	Red	Yellow	0-1100° C	to 1350° C
VT-4116-50RO / SOCKET	K						

Note: Iron and Alumel contacts are magnetic. Constantan and Chromel contacts are non-magnetic.

Termination Information

All inserts are designed for simplified field termination. Control inserts require the use of Vantage crimp tools for safe and reliable circuits. See page CN67 for more information.



XP STARLINE INSERT CONFIGURATIONS

The **Vantage Inserts** presented in this section illustrate the contact configurations available in the Star-Line series. Most inserts are available in alternate key positions to prevent the inter-mating of like configurations in your system. Power inserts (GD/SD) are designed with oversized contacts to maximize cooling. Wire size indicates maximize wire gauge that can be terminated to contact.

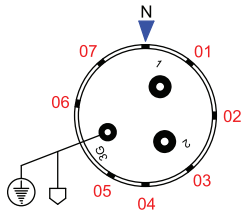

Insert Reference

Pins: GD-16-51PL

Sockets: GD-16-51SL

3 CONTACTS

CONTACT QUANTITY	CONTACT AWG (MM ²)	WIRE AWG (MM ²)	SHELL SIZE
3	4 (25)	8 (10)	16

KEY	POSITION
N	0°
01	40°
02	90°
03	140°
04	180°
05	210°
06	280°
07	320°

	1000 VAC 50/60/400Hz Non-Circuit Breaking	32 AMP
	600 VAC 60/400Hz Circuit Breaking	30 AMP
	480 VAC 60/400Hz Circuit Breaking	30 AMP

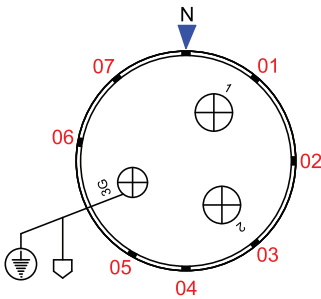

Insert Reference

Pins: GD-20-61PL

Sockets: GD-20-61SL

3 CONTACTS

CONTACT QUANTITY	CONTACT AWG (MM ²)	WIRE AWG (MM ²)	SHELL SIZE
3	1/0 (55)	4 (25)	20

KEY	POSITION
N	0°
01	40°
02	90°
03	140°
04	180°
05	210°
06	280°
07	320°

	1000 VAC 50/60/400Hz Non-Circuit Breaking	63 AMP
	600 VAC 60/400Hz Circuit Breaking	60 AMP
	480 VAC 60/400Hz Circuit Breaking	60 AMP

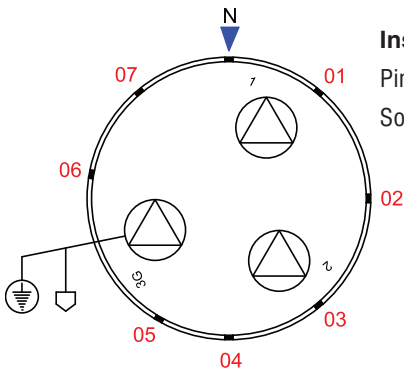

Insert Reference

Pins: GD-24-60PL

Sockets: GD-24-60SL

3 CONTACTS

CONTACT QUANTITY	CONTACT AWG (MM ²)	WIRE AWG (MM ²)	SHELL SIZE
3	4/0 (120)	1/0 (55)	24

KEY	POSITION
N	0°
01	40°
02	90°
03	140°
04	180°
05	210°
06	280°
07	320°

	1000 VAC 50/60/400Hz Non-Circuit Breaking	125 AMP
	600 VAC 60/400Hz Circuit Breaking	100 AMP
	480 VAC 60/400Hz Circuit Breaking	100 AMP

View Shown: Male insert (pins) from front of connector. The female insert (sockets) view is mirrored.

Symbol: Contact grounded to connector shell. Ground pins are longer to make first - break last.	CONTACT SYMBOLS	CONTACT SIZE									
		AWG	mm ²	18	16	12	10	8	4	1/0	4/0
 	CONTACT SIZE	AWG	18	16	12	10	8	4	1/0	4/0	350 MCM
		mm ²	0.75	1.5	4	6	10	25	55	120	185
	WIRE SIZE	AWG	18	16	12	10	8	8	4	1/0	4/0
		mm ²	0.75	1.5	4	6	10	10	25	55	120



EXPLOSIONPROOF STARLINE

XP STARLINE INSERT CONFIGURATIONS

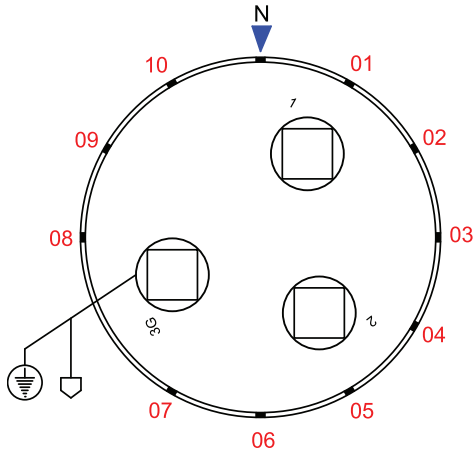

Insert Reference

Pins: GD-28-30PL

Sockets: GD-28-30SL

3 CONTACTS

CONTACT QUANTITY	CONTACT AWG (MM ²)	WIRE AWG (MM ²)	SHELL SIZE
3	350 MCM (185)	4/0 (120)	28

	1000 VAC 50/60/400Hz Non-Circuit Breaking	260 AMP
	600 VAC 60/400Hz Circuit Breaking	200 AMP
	480 VAC 60/400Hz Circuit Breaking	200 AMP

KEY	POSITION
N	0°
01	40°
02	90°
03	140°
04	180°
05	210°
06	280°
07	320°
08	270°
09	300°
10	330°

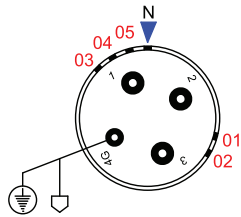

Insert Reference

Pins: GD-16-23PL

Sockets: GD-16-23SL

4 CONTACTS

CONTACT QUANTITY	CONTACT AWG (MM ²)	WIRE AWG (MM ²)	SHELL SIZE
4	4 (25)	8 (10)	16

	1000 VAC 50/60/400Hz Non-Circuit Breaking	32 AMP
	600 VAC 60/400Hz Circuit Breaking	30 AMP
	480 VAC 60/400Hz Circuit Breaking	30 AMP

KEY	POSITION
N	0°
01	105°
02	120°
03	315°
04	330°
05	345°

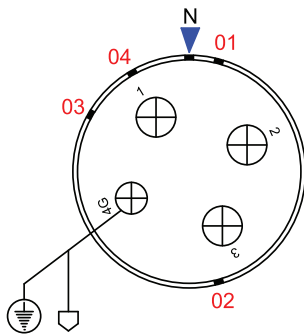

Insert Reference

Pins: GD-20-40PL

Sockets: GD-20-40SL

4 CONTACTS

CONTACT QUANTITY	CONTACT AWG (MM ²)	WIRE AWG (MM ²)	SHELL SIZE
4	1/0 (55)	4 (25)	20

	1000 VAC 50/60/400Hz Non-Circuit Breaking	63 AMP
	600 VAC 60/400Hz Circuit Breaking	60 AMP
	480 VAC 60/400Hz Circuit Breaking	60 AMP

KEY	POSITION
N	0°
01	15°
02	165°
03	300°
04	330°

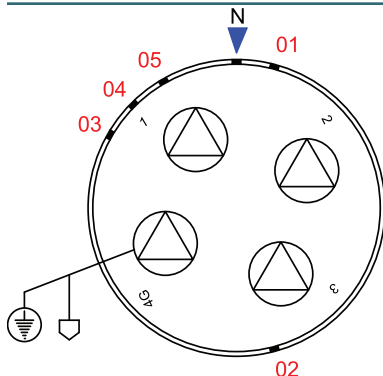

Insert Reference

Pins: GD-24-39PL

Sockets: GD-24-39SL

4 CONTACTS

CONTACT QUANTITY	CONTACT AWG (MM ²)	WIRE AWG (MM ²)	SHELL SIZE
4	4/0 (120)	1/0 (55)	24

	1000 VAC 50/60/400Hz Non-Circuit Breaking	125 AMP
	600 VAC 60/400Hz Circuit Breaking	100 AMP
	480 VAC 60/400Hz Circuit Breaking	100 AMP

KEY	POSITION
N	0°
01	15°
02	165°
03	300°
04	315°
05	330°



XP STARLINE INSERT CONFIGURATIONS

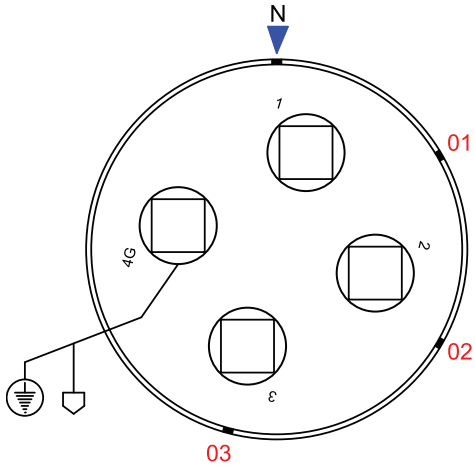

Insert Reference

Pins: GDU-28-31PL

Sockets: GDU-28-31SL

4 CONTACTS

CONTACT QUANTITY	CONTACT AWG (MM ²)	WIRE AWG (MM ²)	SHELL SIZE
4	350 MCM (185)	4/0 (120)	28

	1000 VAC 50/60/400Hz Non-Circuit Breaking	260 AMP
	600 VAC 60/400Hz Circuit Breaking	200 AMP
	480 VAC 60/400Hz Circuit Breaking	200 AMP

KEY	POSITION
N	0°
01	60°
02	120°
03	195°

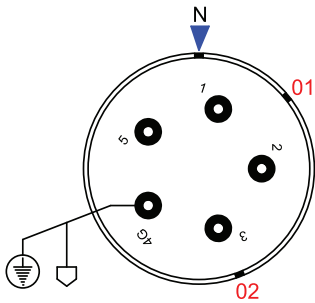

Insert Reference

Pins: GD-20-36PL

Sockets: GD-20-36SL

5 CONTACTS

CONTACT QUANTITY	CONTACT AWG (MM ²)	WIRE AWG (MM ²)	SHELL SIZE
5	4 (25)	8 (10)	20

	1000 VAC 50/60/400Hz Non-Circuit Breaking	32 AMP
	600 VAC 60/400Hz Circuit Breaking	30 AMP
	480 VAC 60/400Hz Circuit Breaking	30 AMP

KEY	POSITION
N	0°
01	51°
02	159°

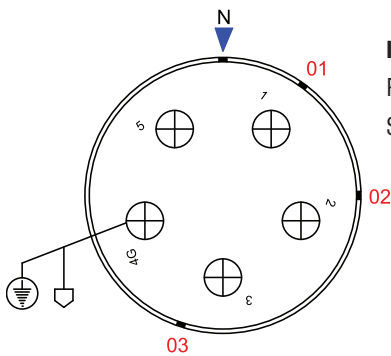

Insert Reference

Pins: GD-24-29PL

Sockets: GD-24-29SL

5 CONTACTS

CONTACT QUANTITY	CONTACT AWG (MM ²)	WIRE AWG (MM ²)	SHELL SIZE
5	1/0 (55)	4 (25)	24

	1000 VAC 50/60/400Hz Non-Circuit Breaking	63 AMP
	600 VAC 60/400Hz Circuit Breaking	60 AMP
	480 VAC 60/400Hz Circuit Breaking	60 AMP

KEY	POSITION
N	0°
01	36°
02	90°
03	198°

View Shown: Male insert (pins) from front of connector. The female insert (sockets) view is mirrored.

Symbol: Contact grounded to connector shell. Ground pins are longer to make first - break last.	CONTACT SYMBOLS	CONTACT SIZE	CONTACT AWG (MM ²)									
			AWG	mm ²	18	16	12	10	8	4	1/0	4/0
PRESSURE CRIMP	CONTACT SIZE	AWG	18	16	12	10	8	4	1/0	4/0	350 MCM	
		mm ²	0.75	1.5	4	6	10	25	55	120	185	
CRIMP	WIRE SIZE	AWG	18	16	12	10	8	8	4	1/0	4/0	
		mm ²	0.75	1.5	4	6	10	10	25	55	120	



EXPLOSIONPROOF STARLINE

XP STARLINE INSERT CONFIGURATIONS

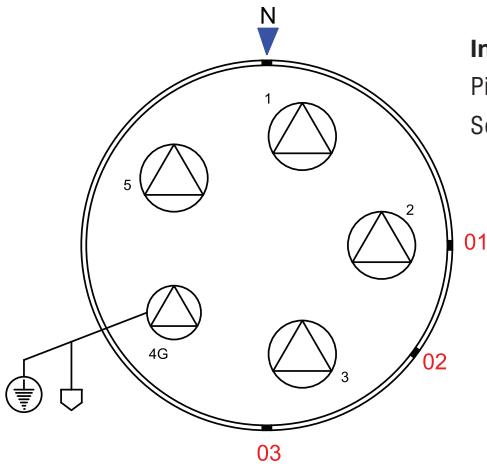

Insert Reference

Pins: GD-28-23PL

Sockets: GD-28-23SL

5 CONTACTS

CONTACT QUANTITY	CONTACT AWG (MM ²)	WIRE AWG (MM ²)	SHELL SIZE
5	4/0 (120)	1/0 (55)	28

	1000 VAC 50/60/400Hz Non-Circuit Breaking	125 AMP
	600 VAC 60/400Hz Circuit Breaking	100 AMP
	480 VAC 60/400Hz Circuit Breaking	100 AMP

KEY	POSITION
N	0°
01	90°
02	126°
03	180°

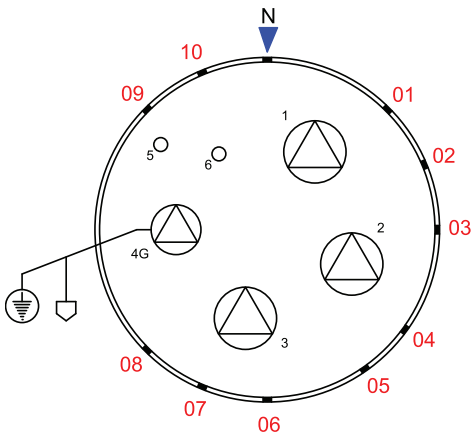

Insert Reference

Pins: GD-28-42PL

Sockets: GD-28-42SL

6 CONTACTS

CONTACT QUANTITY	CONTACT AWG (MM ²)	WIRE AWG (MM ²)	SHELL SIZE
4	4/0 (120)	4/0 (120)	28
2	10 (6)	10 (6)	

	1000 VAC 50/60/400Hz Non-Circuit Breaking	260 AMP
	600 VAC 60/400Hz Circuit Breaking	200 AMP
	480 VAC 60/400Hz Circuit Breaking	200 AMP

KEY	POSITION
N	0°
01	45°
02	67.5°
03	90°
04	126°
05	145°
06	180°
07	202.5°
08	225°
09	315°
10	337.5°

NOTE: Relay pins 5 & 6 are shorter to make last / break first

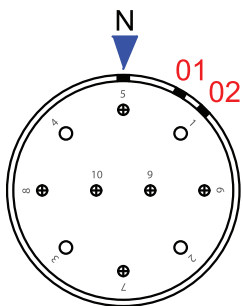

Insert Reference

Pins: VT-16-681PL

Sockets: VT-16-681SL

10 CONTACTS

CONTACT QUANTITY	CONTACT AWG (MM ²)	SHELL SIZE
6	12 (4.0)	16
4	10 (6.0)	

	250 VAC 50/60/400Hz 125 VDC Non-Circuit Breaking	63 AMP
	250 VAC 60Hz Circuit Breaking	60 AMP

KEY	POSITION
N	0°
01	30°
02	45°

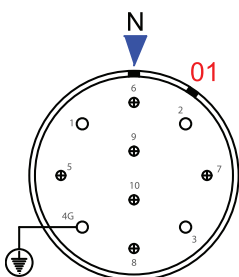

Insert Reference

Pins: VT-16-676PL

Sockets: VT-16-676SL

10 CONTACTS

CONTACT QUANTITY	CONTACT AWG (MM ²)	SHELL SIZE
6	12 (4.0)	16
4	10 (6.0)	

	250 VAC 50/60/400Hz 125 VDC Non-Circuit Breaking	20/30 AMP
	250 VAC 60Hz Circuit Breaking	10 AMP

KEY	POSITION
N	0°
01	30°



XP STARLINE INSERT CONFIGURATIONS

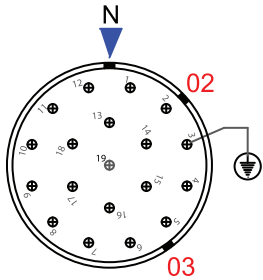

Insert Reference
 Pins: VT-16-612PL
 Sockets: VT-16-612SL

19 CONTACTS

	CONTACT QUANTITY	CONTACT AWG (MM ²)	SHELL SIZE
	19	12 (4)	16

	250 VAC 50/60/400Hz 125 VDC Non-Circuit Breaking	20 AMP

	250 VAC 60Hz Circuit Breaking	10 AMP

KEY	POSITION
N	0°
02	48°
03	144°

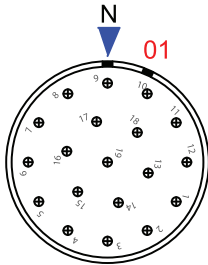

Insert Reference
 Pins: VT-16-677PL
 Sockets: VT-16-677SL

19 CONTACTS

	CONTACT QUANTITY	CONTACT AWG (MM ²)	SHELL SIZE
	19	12 (4)	16

	250 VAC 50/60/400Hz 125 VDC Non-Circuit Breaking	20 AMP

	250 VAC 60Hz Circuit Breaking	10 AMP

KEY	POSITION
N	0°
01	24°

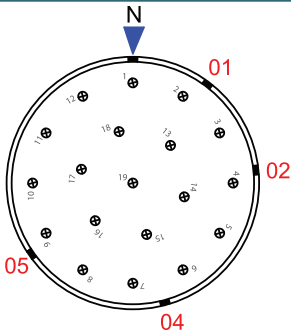

Insert Reference
 Pins: VT-20-676PL
 Sockets: VT-20-676SL

19 CONTACTS

	CONTACT QUANTITY	CONTACT AWG (MM ²)	SHELL SIZE
	19	12 (4)	20

	250 VAC 50/60/400Hz 125 VDC Non-Circuit Breaking	20 AMP

	480 VAC Non-Circuit Breaking 250 VAC Circuit Breaking 60Hz	10 AMP

KEY	POSITION
N	0°
01	37°
02	84°
04	165°
05	235°
02	45°

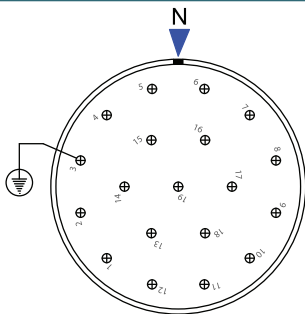

Insert Reference
 Pins: VT-20-688PL
 Sockets: VT-20-688SL

19 CONTACTS

	CONTACT QUANTITY	CONTACT AWG (MM ²)	SHELL SIZE
	19	12 (4)	20

	250 VAC 50/60/400Hz 125 VDC Non-Circuit Breaking	20 AMP

	480 VAC Non-Circuit Breaking 250 VAC Circuit Breaking 60Hz	10 AMP

KEY	POSITION
N	0°

View Shown: Male insert (pins) from front of connector. The female insert (sockets) view is mirrored.

Symbol: Contact grounded to connector shell. Ground pins are longer to make first - break last.	PRESSURE CRIMP 	CONTACT SYMBOLS		○	●	⊕	○	⊙	●	⊕	△	□
		CONTACT SIZE	AWG	18	16	12	10	8	4	1/0	4/0	350 MCM
		mm ²	0.75	1.5	4	6	10	25	55	120	185	
		WIRE SIZE	AWG	18	16	12	10	8	8	4	1/0	4/0
		mm ²	0.75	1.5	4	6	10	10	25	55	120	



EXPLOSIONPROOF STARLINE

XP STARLINE INSERT CONFIGURATIONS

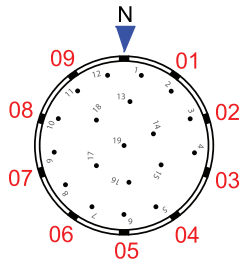

Insert Reference
 Pins: VT-16-655PL
 Sockets: VT-16-655SL

19 CONTACTS

CONTACT QUANTITY	CONTACT AWG (MM ²)	SHELL SIZE
19	16 (1.5)	16

	250 VAC 50/60/400Hz 125 VDC Non-Circuit Breaking	15 AMP
	250 VAC 60Hz Circuit Breaking	6.5 AMP

KEY	POSITION
N	0°
01	36°
02	72°
03	108°
04	144°
05	180°
06	216°
07	252°
08	288°
09	324°

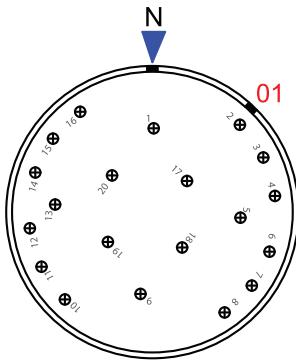

Insert Reference
 Pins: VT-20-632PL
 Sockets: VT-16-632SL

20 CONTACTS

CONTACT QUANTITY	CONTACT AWG (MM ²)	SHELL SIZE
20	12 (4)	20

	250 VAC 50/60/400Hz 125 VDC Non-Circuit Breaking	20 AMP
	250 VAC 60Hz Circuit Breaking	10 AMP

KEY	POSITION
N	0°
01	42.5°

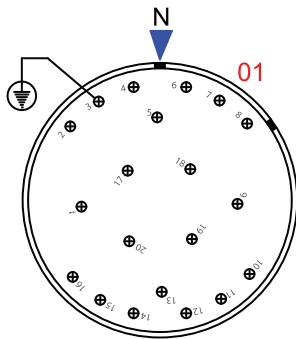

Insert Reference
 Pins: VT-20-687PL
 Sockets: VT-20-687SL

20 CONTACTS

CONTACT QUANTITY	CONTACT AWG (MM ²)	SHELL SIZE
19	12 (4)	20

	250 VAC 50/60/400Hz 125 VDC Non-Circuit Breaking	20 AMP
	250 VAC 60Hz Circuit Breaking	10 AMP

KEY	POSITION
N	0°
01	56°

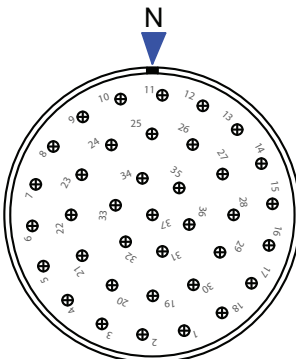

Insert Reference
 Pins: VT-20-686PL
 Sockets: VT-20-686SL

37 CONTACTS

CONTACT QUANTITY	CONTACT AWG (MM ²)	SHELL SIZE
37	12 (4)	20

	250 VAC 50/60/400Hz 125 VDC Non-Circuit Breaking	20 AMP
	250 VAC 60Hz Circuit Breaking	10 AMP

KEY	POSITION
N	0°



XP STARLINE INSERT CONFIGURATIONS

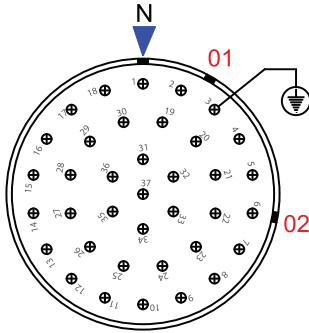

Insert Reference
 Pins: VT-20-650PL
 Sockets: VT-20-650SL

37 CONTACTS

CONTACT QUANTITY		CONTACT AWG (MM ²)	SHELL SIZE
37		12 (4)	20

KEY	POSITION
N	0°
01	30°
02	100°

	250 VAC 50/60/400Hz 125 VDC Non-Circuit Breaking	20 AMP
		250 VAC 60Hz Circuit Breaking

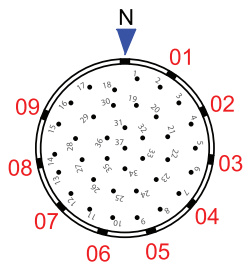

Insert Reference
 Pins: VT-16-621PL
 Sockets: VT-16-621SL

37 CONTACTS

CONTACT QUANTITY		CONTACT AWG (MM ²)	SHELL SIZE
37		16 (1.5)	16

KEY	POSITION
N	0°
01	32.5°
02	65°
03	97.5°
04	130°
05	162.5°
06	195°
07	227.5°
08	260°
09	292.5°

	250 VAC 50/60/400Hz 125 VDC Non-Circuit Breaking	15 AMP
		250 VAC 60Hz Circuit Breaking

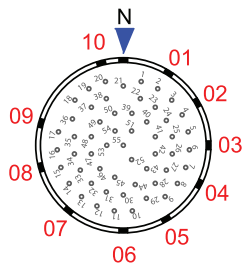

Insert Reference
 Pins: VT-16-640PL
 Sockets: VT-16-640SL

55 CONTACTS

CONTACT QUANTITY		CONTACT AWG (MM ²)	SHELL SIZE
55		18 (0.75)	16

KEY	POSITION
N	0°
01	32°
02	60°
03	90°
04	117°
05	150°
06	180°
07	220°
08	255°
09	285°
10	345°

	250 VAC 50/60/400Hz 125 VDC Non-Circuit Breaking	15 AMP
		250 VAC 60Hz Circuit Breaking

View Shown: Male insert (pins) from front of connector. The female insert (sockets) view is mirrored.

Symbol: Contact grounded to connector shell. Ground pins are longer to make first - break last.	CONTACT SYMBOLS	CONTACT SIZE									
		AWG	18	16	12	10	8	4	1/0	4/0	350 MCM
PRESSURE 	CRIMP 	mm ²	0.75	1.5	4	6	10	25	55	120	185
		AWG	18	16	12	10	8	8	4	1/0	4/0
CRIMP 	CRIMP 	mm ²	0.75	1.5	4	6	10	10	25	55	120
		AWG	18	16	12	10	8	8	4	1/0	4/0



EXPLOSIONPROOF STARLINE

XP STARLINE INSERT CONFIGURATIONS

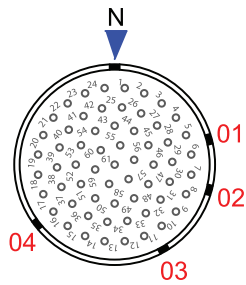

Insert Reference
 Pins: VT-16-633PL
 Sockets: VT-16-633SL

61 CONTACTS

CONTACT QUANTITY		CONTACT AWG (MM ²)	SHELL SIZE
61		18 (0.75)	16

KEY		POSITION
N		0°
01		75°
02		105°
03		150°
04		232.5°

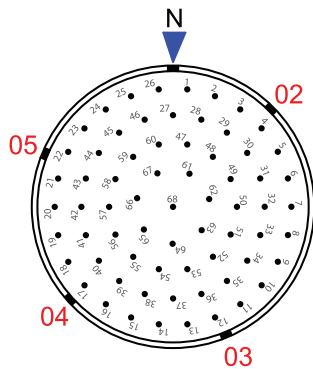

Insert Reference
 Pins: VT-20-613PL
 Sockets: VT-20-613SL

68 CONTACTS

CONTACT QUANTITY		CONTACT AWG (MM ²)	SHELL SIZE
68		16 (1.5)	20

KEY		POSITION
N		0°
02		45°
03		157.5°
04		228°
05		292.5°

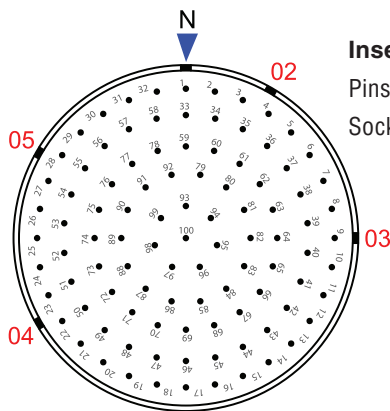

Insert Reference
 Pins: VT-24-613PL
 Sockets: VT-24-613SL

100 CONTACTS

CONTACT QUANTITY		CONTACT AWG (MM ²)	SHELL SIZE
100		16 (1.5)	24

KEY		POSITION
N		0°
02		30°
03		90°
04		240°
05		300°

View Shown: Male insert (pins) from front of connector. The female insert (sockets) view is mirrored.

Symbol: Contact grounded to connector shell. Ground pins are longer to make first - break last.	 PRESSURE CRIMP	CONTACT SYMBOLS		○	●	⊕	○	⦿	●	⊕	△	□
		CONTACT SIZE	AWG	18	16	12	10	8	4	1/0	4/0	350 MCM
WIRE SIZE	AWG	18	16	12	10	8	8	4	1/0	4/0		
	mm ²	0.75	1.5	4	6	10	10	25	55	120	185	120

XP STARLINE ENVIRONMENTAL SEALING

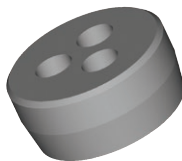
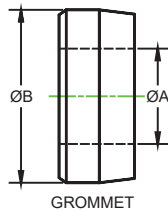
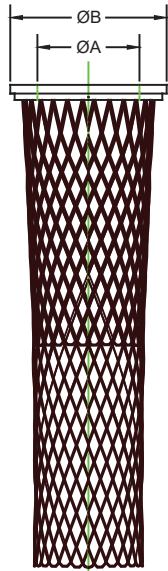
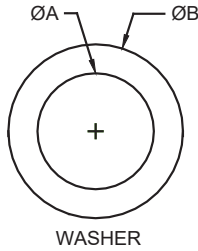

Specialty grommets are available for multi-hole and flat cable systems. Consult factory.



SHELL SIZE DIM B INCHES (MM)	CABLE DIAMETER DIMENSION A INCHES (MM)		CABLE DIAMETER CODE NUMBER*	GROMMET PART NUMBER	WASHER PART NUMBER	BASKET WEAVE GRIP PART NUMBER
	MIN.	MAX.				
16 1 23/32 (43.7)	.250 (6.35)	.375 (9.53)	06	VT-6316-6C	VT-8016-8E	VT-5016-6E VT-5016-8E
	.375 (9.53)	.500 (12.7)	08	VT-6316-8C		
	.500 (12.7)	.625 (15.9)	10	VT-6316-10C	VT-8016-12E	VT-5016-10E VT-5016-12E
	.625 (15.9)	.750 (19.1)	12	VT-6316-12C		
	.750 (19.1)	.875 (22.2)	14	VT-6316-14C	VT-8016-16E	VT-5016-14E VT-5016-16E
	.875 (22.2)	1.000 (25.4)	16	VT-6316-16C		
20 2 7/32 (56.4)	1.000 (25.4)	1.125 (28.6)	18	VT-6316-18C	VT-8016-20E	VT-5016-18E VT-5016-20E
	1.125 (28.6)	1.250 (31.8)	20	VT-6316-20C		
	1.250 (31.8)	1.375 (34.9)	22	VT-6316-22C	VT-8016-23E	VT-5016-22E VT-5016-23E
	1.375 (34.9)	1.437 (36.5)	23	VT-6316-23C		
	.500 (12.7)	.625 (15.9)	10	VT-6320-10C	VT-8020-12E	VT-5020-10E VT-5020-12E
	.625 (15.9)	.750 (19.1)	12	VT-6320-12C		
.750 (19.1)	.875 (22.2)	14	VT-6320-14C	VT-8020-16E	VT-5020-14E VT-5020-16E	
.875 (22.2)	1.000 (25.4)	16	VT-6320-16C			
1.000 (25.4)	1.125 (28.6)	18	VT-6320-18C	VT-8020-20E	VT-5020-18E VT-5020-20E	
1.125 (28.6)	1.250 (31.8)	20	VT-6320-20C			
24 2 23/32 (69.1)	1.250 (31.8)	1.375 (34.9)	22	VT-6320-22C	VT-8020-24E	VT-5020-22E VT-5020-24E
	1.375 (34.9)	1.500 (38.1)	24	VT-6320-24C		
	1.500 (38.1)	1.625 (41.3)	26	VT-6320-26C	VT-8020-28E	VT-5020-26E VT-5020-28E
	1.625 (41.3)	1.750 (44.5)	28	VT-6320-28C		
	1.750 (44.5)	1.875 (47.6)	30	VT-6320-30C	VT-8020-31E	VT-5020-30E VT-5020-31E
	1.875 (47.6)	1.937 (49.2)	31	VT-6320-31C		
28 3 5/32 (80.2)	.875 (22.2)	1.000 (25.4)	16	VT-6324-16C	VT-8024-16E	VT-5024-16E
	1.000 (25.4)	1.125 (28.6)	18	VT-6324-18C		
	1.125 (28.6)	1.250 (31.8)	20	VT-6324-20C	VT-8024-20E	VT-5024-18E VT-5024-20E
	1.250 (31.8)	1.375 (34.9)	22	VT-6324-22C		
	1.375 (34.9)	1.500 (38.1)	24	VT-6324-24C	VT-8024-24E	VT-5024-22E VT-5024-24E
	1.500 (38.1)	1.625 (41.3)	26	VT-6324-26C		
1.625 (41.3)	1.750 (44.5)	28	VT-6324-28C	VT-8024-28E	VT-5024-26E VT-5024-28E	
1.750 (44.5)	1.875 (47.6)	30	VT-6324-30C			
1.875 (47.6)	2.000 (50.8)	32	VT-6324-32C	VT-8024-32E	VT-5024-30E VT-5024-32E	
2.000 (50.8)	2.125 (54.0)	34	VT-6324-34C			
2.125 (54.0)	2.250 (57.2)	36	VT-6324-36C	VT-8024-36E	VT-5024-34E VT-5024-36E	
2.250 (57.2)	2.375 (60.3)	38	VT-6324-38C			
2.375 (60.3)	2.437 (61.9)	39	VT-6324-39C	VT-8024-39E	VT-5024-38E VT-5024-39E	
1.375 (34.9)	1.500 (38.1)	24	VT-6328-24C			VT-8028-24E
1.500 (38.1)	1.625 (41.3)	26	VT-6328-26C			
1.625 (41.3)	1.750 (44.5)	28	VT-6328-28C	VT-8028-28E	VT-5028-26E VT-5028-28E	
1.750 (44.5)	1.875 (47.6)	30	VT-6328-30C			
1.875 (47.6)	2.000 (50.8)	32	VT-6328-32C	VT-8028-32E	VT-5028-30E VT-5028-32E	
2.000 (50.8)	2.125 (54.0)	34	VT-6328-34C			
2.125 (54.0)	2.250 (57.2)	36	VT-6328-36C	VT-8028-36E	VT-5028-34E VT-5028-36E	
2.250 (57.2)	2.375 (60.3)	38	VT-6328-38C			
2.375 (60.3)	2.500 (63.5)	40	VT-6328-40C	VT-8028-40E	VT-5028-38E VT-5028-40E	
2.500 (63.5)	2.625 (66.7)	42	VT-6328-42C			
2.625 (66.7)	2.750 (68.9)	44	VT-6328-44C	VT-8028-44E	VT-5028-42E VT-5028-44E	
2.750 (68.9)	2.875 (73.0)	46	VT-6328-46C			

* The cable diameter code is used to define the grommet size in the connector part number. For example, connector AF-B1516-621SL-18 comes with a size "18" grommet, for use with a cable whose diameter range is 1.000 - 1.125 inches (25.4 - 28.6mm).



EXPLOSIONPROOF STARLINE

TOOLING



Pressure Termination for safe and reliable assembly in the field.

Vantage offers a full line of tooling to assist in the termination and assembly of our attachment plugs and receptacles. Star-Line, GD/SD Series and Strate-Line power connectors, feature pressure termination and come with all required tooling. For Star-Line control connectors, the AF/SF Series, Vantage requires using a full-cycle eight indent crimp tool. Please contact us for assistance in specifying your tooling needs.

Crimp Tools



T-104-CT-K Crimp Tool Kit. Hand tool with accessories for contacts #18 through #10 (carrying case and tool inspection gage not shown).

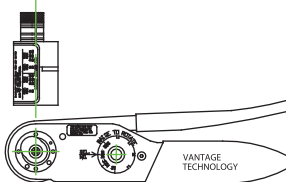

T-103-CT-K Crimp Tool Kit. Hand tool with accessories for contacts #18 through #10, shown with turret head detached (carrying case and tool inspection gage not shown).

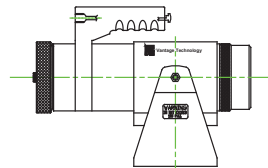

T-105-HE, Pneumatic Crimp Tool. Available with dies, locators and inspection gages for #18 through #4/0 contacts. A foot control is also available. Operates on shop air and inert gas cylinders at 100 PSI.

Contact Extraction Tool

Pin and socket contact extraction tool for AF and SF control connectors.

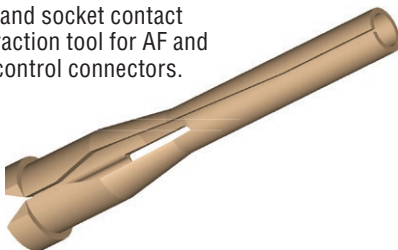

CONTACT SIZE	EXTRACTION TOOL PART NUMBER
18	T-106-18
16	T-106-16
12	T-106-12
10	T-106-10

Assembly Tools

Plug Assembly Tool Furnished with plug.

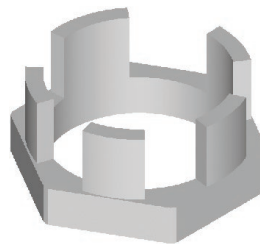

SHELL SIZE	PART NUMBER	
	PLUG ASSEMBLY TOOL	PLUG DISASSEMBLY TOOL
16	T-101-16A	T-102-16R
20	T-101-20A	T-102-20R
24	T-101-24A	T-102-24R
28	T-101-28A	T-102-28R

Plug Disassembly Tool Ordered separately.

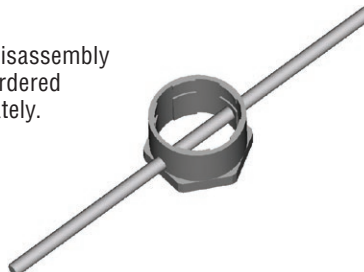

Cable Assemblies



Complete cable assemblies and receptacle distribution boxes are available incorporating Vantage Technology connectors. Please contact us regarding specification options.

CONNECTORS



FIREMATE™

CONNECTOR



MADE IN BRITAIN

The **FireMate** safety critical connector has been developed to be used on underground and overground rail networks, commercial and public buildings where it is critical for equipment to work during an evacuation and rescue situation.

Tested to the latest fire standards **BS EN50200:2006 and BS8434-2:2003 + A2 2009** our connector will maintain its electrical and structural integrity during the harshest of fire conditions. The product is designed to be used in escape route safety equipment; emergency lighting circuits; fire alarms; voice alarms; shutdown systems; fire detection.

TECHNICAL DATA	
CONSTRUCTION AND TEST STANDARDS:	BS5839-1 2013 section 26.2 e), BS EN50200:2006, BS8434-2:2003 + A2 2009, BS EN61984, BS5266-2016 -8.2.2 b d, GPSD (2001/95/EC)
INGRESS PROTECTION:	IP66
MATERIAL:	Nickel Plated Brass
OPERATING TEMPERATURE:	Range: -25°C to +70°C
SEALING ARRANGEMENT:	Single compression seal
EARTH:	Electrical continuity using earth pin and body connection
CABLE TYPE:	Unarmoured fire rated cable
NUMBER OF CORES:	4 + Earth Dali ready
CORE SIZE:	Up to 6mm ²
CURRENT RANGE:	16 Amps
VOLTAGE RANGE:	240 VAC
ASSEMBLY INSTRUCTIONS	AI 503
MAX NO. OF MAKE & BREAK OPERATIONS (EN61984): ON AND OFF LOAD	≥500

FIRE TEST	
IN ACCORDANCE WITH BS EN50200: 2006 (Resistance to fire with mechanical shock)	120MINS AT 830 (+40-0)°C with mechanical shock and a rated voltage of 240v rms.
FIRE TEST: IN ACCORDANCE WITH BS 8434-2:2003 +A2 2009 (Resistance to fire with mechanical shock and water spray)	120MINS AT 930 (+40-0)°C with mechanical shock and a rated voltage of 240v rms. (60 mins fire and shock and 60 mins fire, shock and water)

ORDERING OPTIONS		
MANUFACTURE	Hawke	H
TYPE	FireMate	FM
MATERIAL	Nickel Plated Brass	N
	Stainless Steel	S
CONNECTOR STYLE <i>The CP is always supplied with pin contacts</i>	Connector Plug	CP
	Connector Receptacle	CR
	Bulkhead Receptacle	BR
	Besa Box Receptacle	BB
FUSE PIN	3 Amp	F3
	5 Amp	F5
	10 Amp	F10
	15 Amp	F15
	Not Required or N/A for receptacle	X

Fuse pins are used as part of the standard wiring operation and will not meet the increased fire rating of this connector.

SAMPLE ORDER CODE	
MANUFACTURE/TYPE/MATERIAL ETC	H/FM/S/CP = Hawke, FireMate, Stainless Steel, Connector Plug.

FEATURES

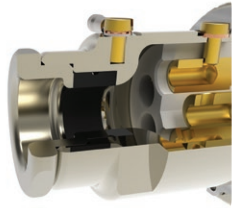

1 Unique fireproof rear intumescent seal to accommodate a wide range of cables.

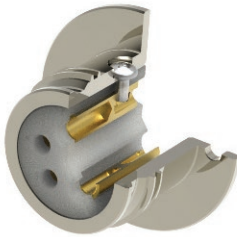

2 Quick Connect via a 4 start thread Earth and Key location screw.



3 Unique high temperature pin and socket insert. Integral moulded keyway to ensure fool proof assembly.

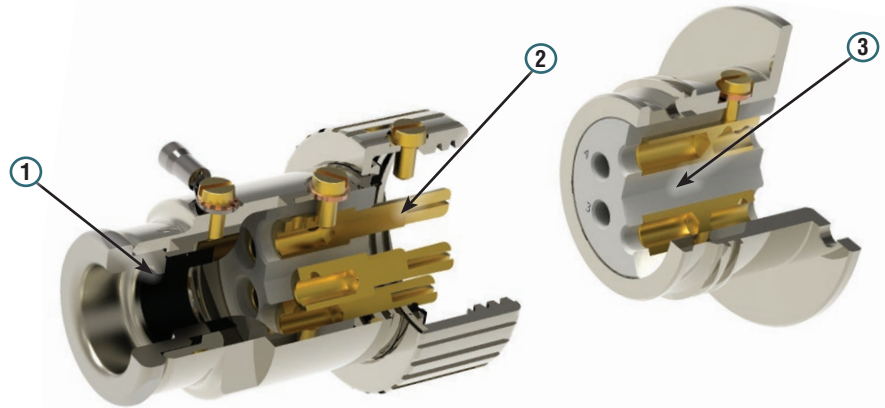

Besa Box Receptacle to Connector Plug
For Besa Box Mounting

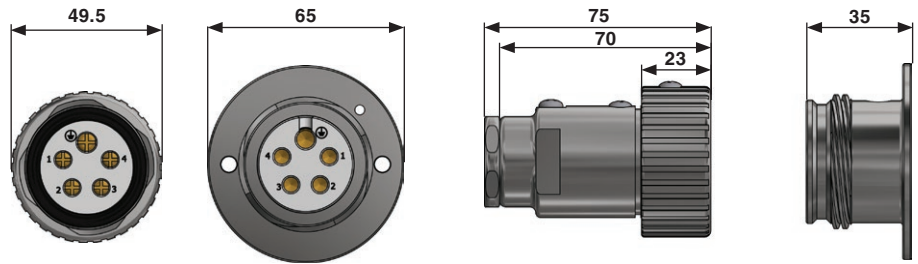

Bulkhead Receptacle to Connector Plug
For Enclosure/Equipment Mounting

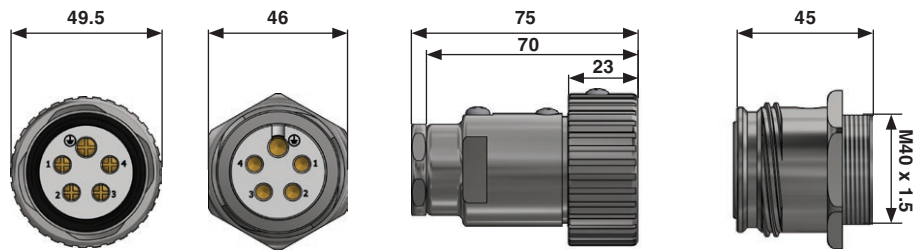

Connector Receptacle to Connector Plug
For Inline Connections

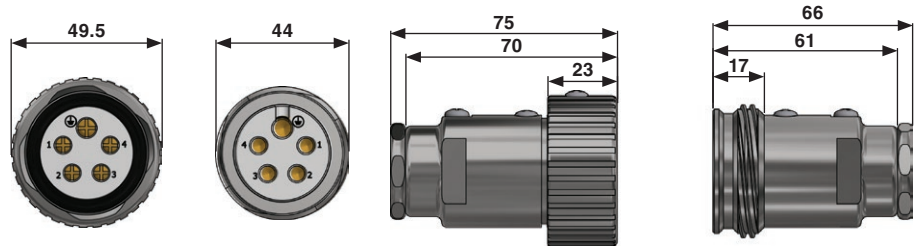

Connector plugs and connector receptacles accept a cable OD of 11mm to 14.3mm.

For any cable OD outside of these sizes, please contact Hawke Sales for more details. All bulkhead receptacles are supplied with an M40 entry.

CONNECTORS

TOUGHMATE™



CONNECTOR



MADE IN BRITAIN

The **ToughMate** connector has been developed to be used on underground and overground rail networks, commercial and public buildings where equipment needs to withstand the harshest of environments.

Tested to the latest Industrial **BS EN 61984** and **LVD 2014/35/ EU** our connector will maintain its electrical and structural integrity during the toughest conditions. The product is designed to be used in emergency lighting circuits; fire alarms; voice alarms; shutdown systems and fire detection.

TECHNICAL DATA	
CONSTRUCTION AND TEST STANDARDS:	BS EN 61984, GPSD (2001/95/EC)
INGRESS PROTECTION:	IP66
MATERIAL:	Nickel Plated Brass or Stainless Steel 316
OPERATING TEMPERATURE:	Range: -25°C to +70°C
SEALING ARRANGEMENT:	Single compression seal
EARTH:	Electrical continuity using earth pin and body connection
CABLE TYPE:	Unarmoured cable
NUMBER OF CORES:	4 + Earth Dali ready
CORE SIZE:	Up to 6mm ²
CURRENT RANGE:	5, 10 & 15 Amps with Fuse, 16 Amps without
VOLTAGE RANGE:	240 VAC
ASSEMBLY INSTRUCTIONS:	AI 504
MAX NO. OF MAKE & BREAK OPERATIONS (EN61984): ON AND OFF LOAD	≥500

ORDERING OPTIONS		
MANUFACTURE	Hawke	H
TYPE	ToughMate	TM
MATERIAL	Nickel Plated Brass	N
	Stainless Steel	S
CONNECTOR STYLE <i>The CP is always supplied with pin contacts</i>	Connector Plug	CP
	Connector Receptacle	CR
	Bulkhead Receptacle	BR
	Besa Box Receptacle	BB
FUSE PIN	3 Amp	F3
	5 Amp	F5
	10 Amp	F10
	15 Amp	F15
	Not Required or N/A for receptacle	X

* For best practice please ensure that the socket side is energised only

SAMPLE ORDER CODE	
MANUFACTURE/TYPE/MATERIAL ETC	H/TM/S/CP/F5 = Hawke, ToughMate, Stainless Steel, Connector Plug, with 5Amp Fuse.

FEATURES

- 1 Unique fuse pin design available to give circuit protection without the need for enclosures.
- 2 Quick Connect via a 4 start thread Earth and Key location screw
- 3 Custom peg design to ensure correct mating locations every time.

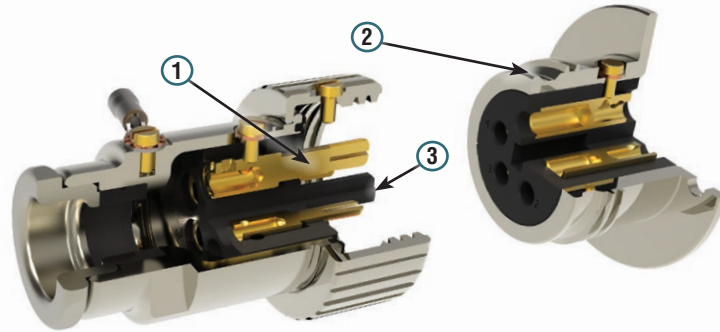

Besa Box Receptacle to Connector Plug
For Besa Box Mounting

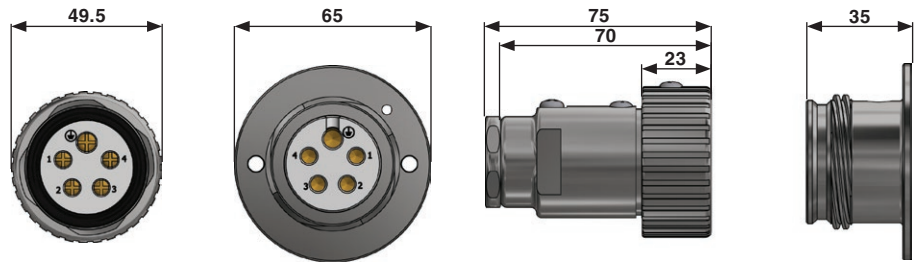

Bulkhead Receptacle to Connector Plug
For Enclosure/Equipment Mounting

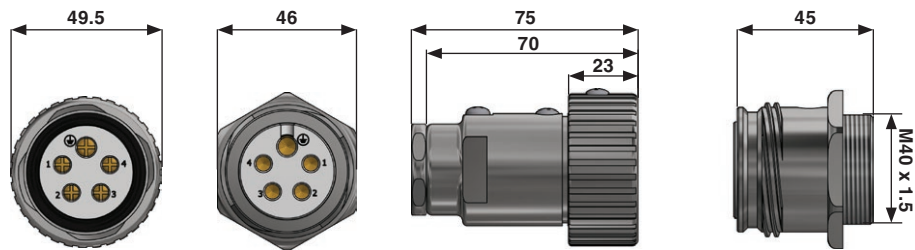

Connector Receptacle to Connector Plug
For Inline Connections

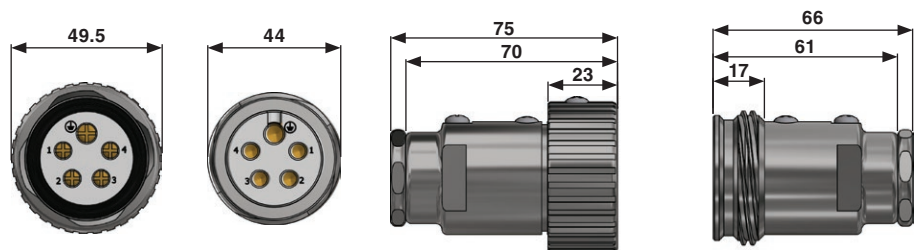

Connector plugs and connector receptacles accept a cable OD of 10mm to 14mm.

For any cable OD outside of these sizes, please contact Hawke Sales for more details. All bulkhead receptacles are supplied with an M40 entry.



INTRODUCTION • NEMA 4X METALLIC



VR/VP



ALLEN/SLOT
TERMINALS

600 VAC/250VDC; 50-400 hertz
NEMA 3, 4, 4X



FEATURES-SPECIFICATIONS

NEMA 4X VersaMATE®

THE FIRST NEMA 4X RATED LINE OF METALLIC PLUGS & RECEPTACLES.

VersaMate® metallic pin & sleeve plugs & receptacles are designed for heavy duty industrial use. These devices supply power to both fixed and portable electrical equipment including pumps, generators, welders, vacuums, blowers and similar apparatus.

Suitable for indoor or outdoor use. Applications include the wet, cold, hosedown, hazardous or corrosive areas in such industrial applications as:

- Pulp & Paper Mills
- Electrical Power Plants
- Petrochemical Plants
- Wastewater Treatment
- Marine, Docks, Ports
- Construction Sites
- Breweries
- Refineries
- Chemical Plants
- Grain Facilities
- Textile Manufacturing
- Food Processing Facilities

① VersaMate® components are UL classified and intermateable with other UL 1686-C1 configured devices (when installed in accordance with instructions furnished with device). Assemblies containing components from other manufacturers would have the NEMA type rating of the lowest rated device. 150A models UL intermateable w/Appleton® Powertite® only.

② See product pages for specific ratings.

Arktite® is a registered trademark of Crouse-Hinds®. Powertite® is a registered trademark of Appleton®.

Standard Materials:

Copper-free aluminum construction with electrostatically applied epoxy/polyester finish. Contacts are brass with a patented beryllium copper spring tensioner. External screws are 316 stainless steel.

Features:

The VersaMate product line includes 30, 60, 150[Ⓞ], 100 and 200 Amp plugs, receptacles and connectors with a full range of back boxes. Popular options include reverse service and polarization. The VersaMate line is **FULLY INTERCHANGEABLE**® with UL1686 configured and listed devices such as Crouse-Hinds® Arktite® or Appleton® Powertite®. Standard location receptacle bolt hole patterns match competitive back boxes so users can upgrade to VersaMate without changing back boxes in instances where changing the conduit system is difficult.

Plugs:

Octagonal style (patented) for a firm and sure grip when connecting or disconnecting is featured on both plug and cable connector bodies. Insulators have high mechanical and dielectric strength and are “Low Arc Tracking.” “Increased Safety” type box terminals with gripper ribs securely clamp around conductors. Funneled conductor entry chambers lead all properly stripped conductors into terminals **simultaneously**. NEMA 4X rating when inserted into VersaMate receptacle and locking ring is tightened. Includes suitability for Type P marine cable.



Receptacles:

Exclusive Patented “Breech-Lock” cap serves as either flip lid or screw cover. Receptacle is NEMA 3R with lid snapped shut or NEMA 4X with lid turned shut or when VersaMate plug is inserted and locking ring tightened. Patented notch in cap arm holds cap open for easy plug insertion or maintenance. Patented pin design uses slotted spring clip which avoids excessive wear while providing continuous electrical pin to sleeve contact. VersaMate® receptacles use the same “Increased Safety” terminals and funnel design as VersaMate® plugs.



Cable Clamping Assembly:

Plugs and cable connectors are supplied with an exclusive neoprene “Onion Skin” peel-away type grommet. The VersaMate® cable clamp system captures cable with **four grip points** using **only two** tightening screws. Clamp guide assembly provides a firm fit over a wide range of cable diameters. Non-removable set screws prevent clamp guide assembly from backing out. Clamps have smooth contoured shoulder design to prevent snags or damage when moving equipment.



Back Boxes:

VersaMate back boxes come in a variety of mounting styles. Exclusive “blind” receptacle mounting holes prevent moisture from entering box via thread cavities. Boxes come with a green grounding screw.





















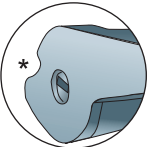

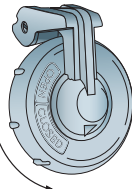
FEATURES / COMPARISONS

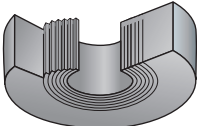

- First NEMA 4X – Still the BEST!
- Exclusive interior gasketing
- Exclusive Terminal Designs
 - » No conductor machining
 - » Allen or Phillips types

- Exclusive Onion-Skin Gasket
 - » Perfect Cable Fit
- Exclusive 4-Point Cable Grip
 - » Uses only 2 Recessed Screws
- Exclusive Breech-Lock Cap
 - » Flip or Screw-On
 - » Notch to hold open

KILLARK BRAND		RECEPTACLE/CONNECTOR PIN CONFIGURATION							
TERMINALS		STYLE 1			STYLE 2				
		AMPS	POLES AND WIRES	RECEPTACLE/CONNECTOR CONFIGURATION*	AMPS	POLES AND WIRES	RECEPTACLE/CONNECTOR CONFIGURATION*		
New Allen/slot terminal screws do not contact or machine conductor. Allows higher torque values typical in the oil industry.		30	2W2P		30	2W3P			
VersaMate original Phillips/slot "Increased Safety" type terminals reduce connection fatigue. Screws do not contact or machine conductor and are under spring tension to reduce loosening and pullout due to vibration.			3W3P			3W4P			
CAP			60	4W4P		60	2W3P		
	"Breech-Lock" design serves as both flip lid or screw cover style. Special notch in lid arm holds cover open to ease plug insertion or maintenance. *Slip pencil or screwdriver into notch.	100		2W2P			100	3W4P	
			3W3P		2W3P				
GASKET			150A	4W4P		150A	3W4P		
	Exclusive "Onion Skin" style gasket assures a tight seal around cable. Skin layers are removed from a single gasket to adjust for various cable diameters.	200		3W3P			200	2W3P	
				4W4P				3W4P	

REVERSE SERVICE: S39

Add suffix **S39** for factory Reverse Service of receptacles, plugs or connectors. Receptacles or connectors are assembled with plug interiors while plugs are assembled with receptacle interiors. For applications where the plug is energized (i.e. from a generator) to feed a non-energized receptacle. Prevents easy contact with energized exposed pins. This conversion can be performed in the field with a complementary plug and receptacle (30A to 150A devices shown on pages PR5-PR8). 200A Amp devices shown on page PR9 are a factory-only option. Reverse service is not for hazardous locations.



Typical Application

POLARIZED OPTION: S37

Add suffix **S37** for special polarity.

Can prevent connection between mismatched voltages or frequencies in areas where devices of the same amperage, poles and grounding style are used. Receptacle or connector interiors are rotated 22-1/2° to the right; plug is rotated opposite to match. This is a factory only option.

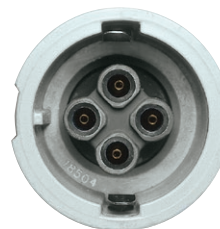

Standard

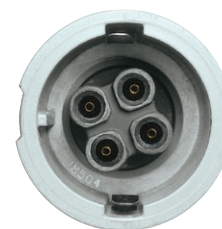

S37 Option

EXCLUSIVE FEATURES & GROUNDING METHODS



P Patented Exclusive “Breech-Lock” cap serves as either flip lid or screw cover

- NEMA 3R Rating: When receptacle cap is snapped shut
- NEMA 4X Rating: When receptacle cap is turned shut or with VersaMate® plug inserted and ring tightened

P Patented Special notch is designed to hold cap open for easy field service or plug insertion with **two** free hands

• Funneled wiring chamber design for fast and accurate conductor insertion to speed assembly. All wires can be inserted at **one time**

• Exclusive neoprene “Onion Skin” peel-away type gasket for the ultimate in sealing a variety of cable sizes

• The VersaMate® Cable clamp system captures cable with four grip points using only two tightening screws. Provides secure grip without damaging the cable insulation

• **Unique VersaMate® Feature**
The VersaMate Line is designed for the industrial customer based on engineering and user surveys

P Denotes Patented Feature

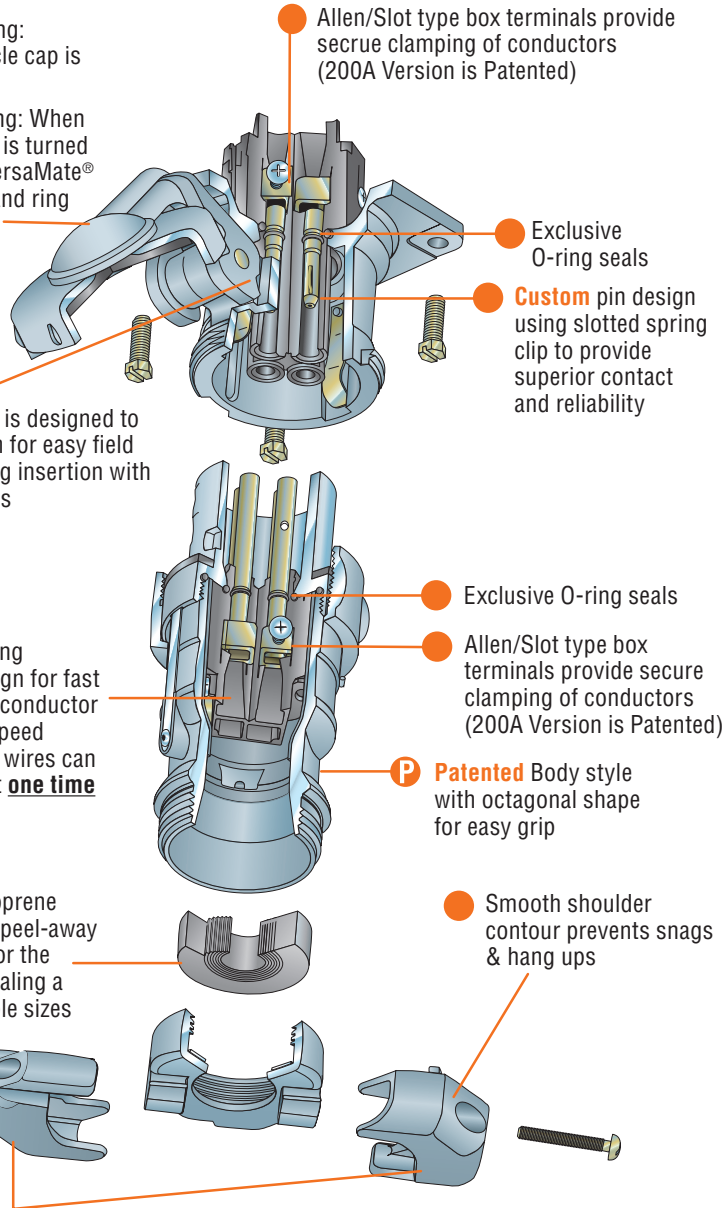

Grounding:

To minimize the danger of electrical shock when utilizing portable equipment, the National Electrical Code requires exposed metal parts be grounded if operated at more than 150 volts to ground. The VersaMate® plug & receptacle system is available in two grounding styles. Please note Style I and II devices cannot be intermated.

Style I

In a Style I plug, the cable's ground conductor is bonded to the plug housing by means of solderless connector. The receptacle is grounded by being part of a grounded conduit system. Upon insertion, detent springs in the receptacle housing contact and ground the plug housing before current carrying poles.

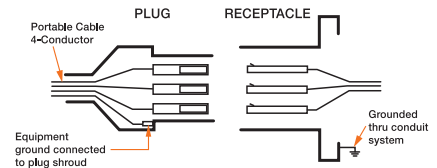
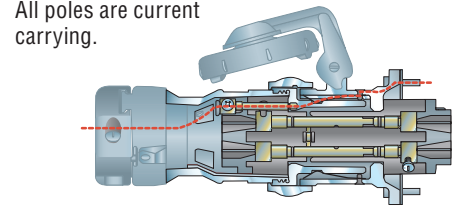

3W3P Illustrated

Style II

In a Style II plug, the cable's ground conductor is bonded to the extra grounding pole and to the plug housing via a bonding jumper. The receptacle has a matching grounding pole connected to the system ground conductor which is further tied to the grounded conduit system via a bonding jumper. Upon insertion, detent springs in the receptacle housing contact and ground the plug housing; then the extra long ground pole connects before the current carrying poles engage. The Style II ground pole makes first and breaks last.

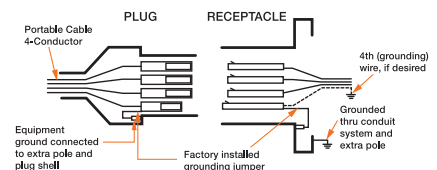
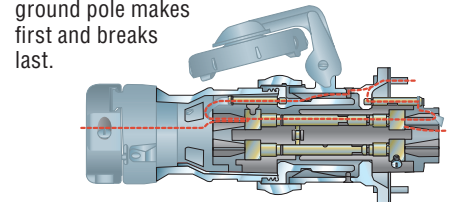

3W4P Illustrated



VERSAMATE® SERIES

30A SELECTION INFORMATION

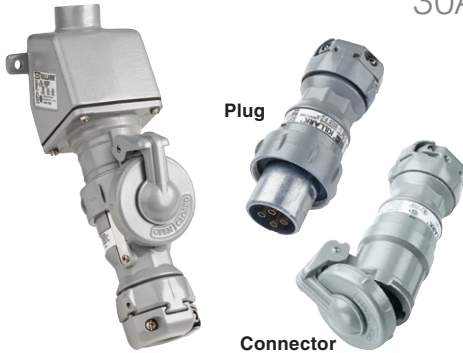

Plug

Connector

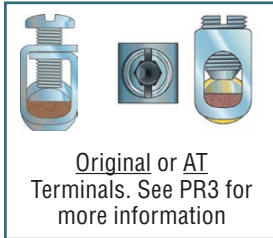

Original or AT
Terminals. See PR3 for
more information

• 30 Amp 600VAC/250VDC; 50-400 Hertz
NEMA 3, 4, 4X①

Wire Range

Regular Stranding: #10 - #6 original style or "AT" type
(Includes Type P marine)
Extra flex: #10 - #8 original style or "AT" type

UL File No. E10757 NSF Certified File No. LR111846

FEATURES-SPECIFICATIONS

30 AMP PLUGS & CONNECTORS						
GROUND STYLE	CIRCUIT	GROMMET RANGE	CATALOG NUMBER			
			PLUG		CONNECTOR	
			ORIG.	AT	ORIG.	AT
Style I	2W2P	.55 - 1.20 IN	VP3275	VP3022	VPR3255	VPR3022
	3W3P	.55 - 1.20 IN	VP3375	VP3033	VPR3355	VPR3033
	4W4P	.55 - 1.20 IN	VP3475	VP3044	VPR3455	VPR3044
Style II	2W3P	.55 - 1.20 IN	VP3385	VP3023	VPR3365	VPR3023
	3W4P	.55 - 1.20 IN	VP3485	VP3034	VPR3465	VPR3034

MODIFICATIONS*	
CATALOG NUMBER	DESCRIPTION
S39	Reverse service for receptacles, plugs & connectors
S37	Polarization for receptacles, plugs & connectors

* See page PR3 for more information on these options.

30 AMP RECEPTACLES & BACK BOXES									
GROUND STYLE	CIRCUIT	CATALOG NUMBER							
		EⓂ TYPE DEAD END		CⓂ TYPE FEED THRU		DⓂ TYPE ANGLED FEED THRU		RECEPTACLE ONLY	
		ORIG.	AT	ORIG.	AT	ORIG.	AT	ORIG.	AT
Style I	2W2P	VR321E2	VR3022E2	VR321C2	VR3022C2	VR321D2	VR3022D2	VR321	VR3022
	3W3P	VR331E2	VR3033E2	VR331C2	VR3033C2	VR331D2	VR3033D2	VR331	VR3033
	4W4P	VR341E2	VR3044E2	VR341C2	VR3044C2	VR341D2	VR3044D2	VR341	VR3044
Style II	2W3P	VR332E2	VR3023E2	VR332C2	VR3023C2	VR332D2	VR3023D2	VR332	VR3023
	3W4P	VR342E2	VR3034E2	VR342C2	VR3034C2	VR342D2	VR3034D2	VR342	VR3034
Splice box onlyⓂ		VRE23	VRE23	VRC23	VRC23	VRD23	VRD23	-	-

① Components are interchangeable & UL classified with other UL1686 configured devices (when installed in accordance with instructions furnished with device). Assemblies containing components from other manufacturers would have the NEMA type rating of the lowest rated device.

- Note, 2, 3 & 4 pole device dimensions are the same.

Ⓜ 30 Amp Back Boxes are available in 1/2", 3/4" and 1" conduit sizes. Size listed for 3/4". For other available sizes, change the BOLD "2" in either the assembly or box only number to: **1**=1/2", **2**=3/4", **3**=1". Assembly catalog numbers are listed for ease of ordering or specification and devices are shipped as components.

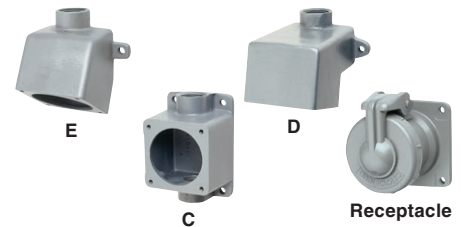

Receptacle

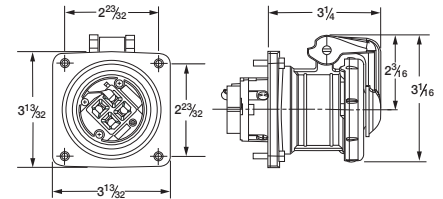

Plug

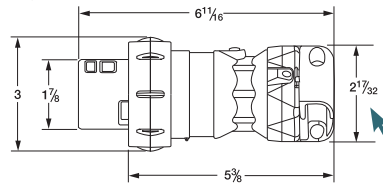

VersaMate® clamps provide a firm fit for one plug (or connector) over a wide range of cable diameters (competitors often need two - requiring additional sizing decisions).

Connector

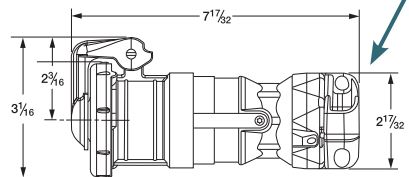

Back Box Dimensions

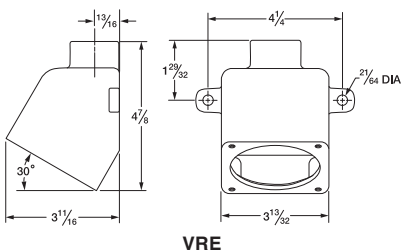

VRE

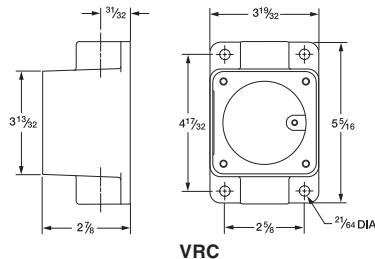

VRC

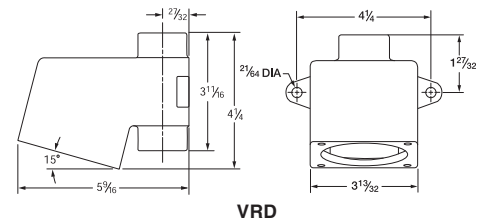

VRD

CONNECTORS

VERSAMATE® SERIES



60A SELECTION INFORMATION

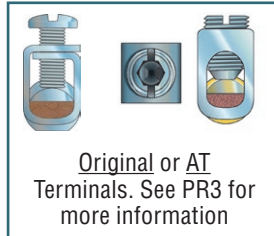
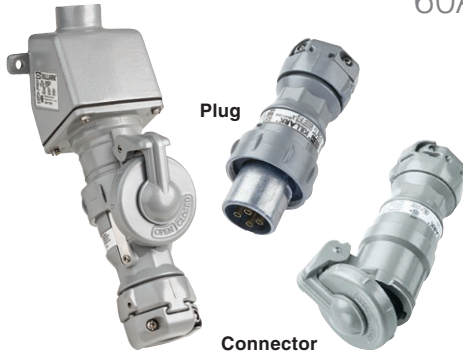

Original or AT
Terminals. See PR3 for
more information

• 60 Amp 600VAC/250VDC; 50-400 Hertz
NEMA 3, 4, 4X^①

Wire Range

Regular Stranding: #6 - #2 original style or "AT" type
(Includes Type P marine)

Extra flex: #6 - #4 original style or "AT" type

UL File No. E10757 NSF Certified File No. LR111846

FEATURES-SPECIFICATIONS

60 AMP PLUGS & CONNECTORS

GROUND STYLE	CIRCUIT	GROMMET RANGE	CATALOG NUMBER			
			PLUG		CONNECTOR	
			ORIG.	AT	ORIG.	AT
Style I	2W2P	.65 - 1.50 IN	VP6275	VP6022	VPR6255	VPR6022
	3W3P	.65 - 1.50 IN	VP6375	VP6033	VPR6355	VPR6033
	4W4P	.65 - 1.50 IN	VP6475	VP6044	VPR6455	VPR6044
Style II	2W3P	.65 - 1.50 IN	VP6385	VP6023	VPR6365	VPR6023
	3W4P	.65 - 1.50 IN	VP6485	VP6034	VPR6465	VPR6034

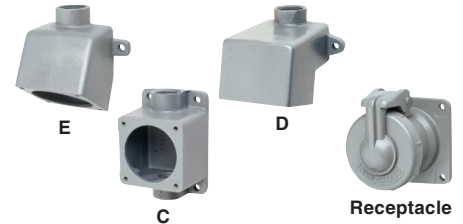

Receptacle

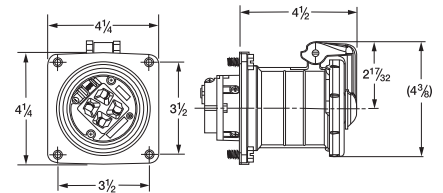

MODIFICATIONS*

CATALOG NUMBER	DESCRIPTION
S39	Reverse service for receptacles, plugs & connectors
S37	Polarization for receptacles, plugs & connectors

* See page PR3 for more information on these options.

60 AMP RECEPTACLES & BACK BOXES

GROUND STYLE	CIRCUIT	CATALOG NUMBER							
		E ^② TYPE DEAD END		C ^② TYPE FEED THRU		D ^② TYPE ANGLED FEED THRU		RECEPTACLE ONLY	
		ORIG.	AT	ORIG.	AT	ORIG.	AT	ORIG.	AT
Style I	2W2P	VR621E4	VR6022E4	VR621C4	VR6022C4	VR621D4	VR6022D4	VR621	VR6022
	3W3P	VR631E4	VR6033E4	VR631C4	VR6033C4	VR631D4	VR6033D4	VR631	VR6033
	4W4P	VR641E4	VR6044E4	VR641C4	VR6044C4	VR641D4	VR6044D4	VR641	VR6044
Style II	2W3P	VR632E4	VR6023E4	VR632C4	VR6023C4	VR632D4	VR6023D4	VR632	VR6023
	3W4P	VR642E4	VR6034E4	VR642C4	VR6034C4	VR642D4	VR6034D4	VR642	VR6034
Splice box only ^③		VRE46	VRE46	VRC46	VRC46	VRD46	VRD46	-	-

Plug

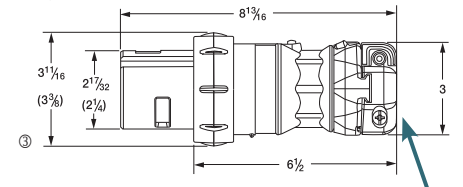

VersaMate® clamps provide a firm fit for one plug (or connector) over a wide range of cable diameters (competitors often need two - requiring additional sizing decisions).

Connector

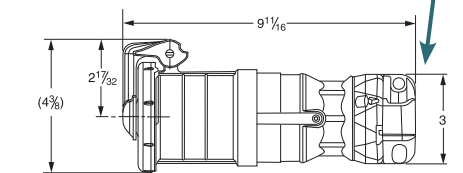

Back Box Dimensions

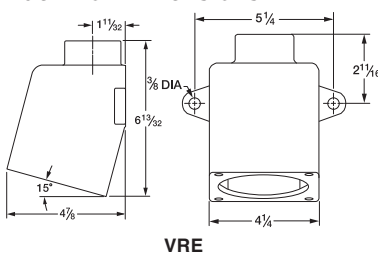

VRE

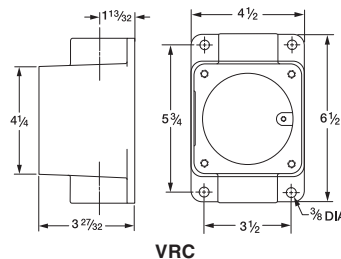

VRC

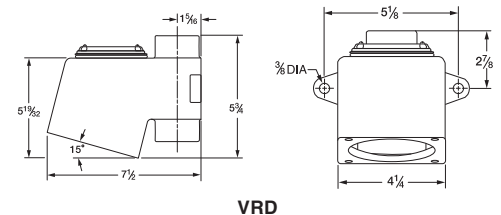

VRD



VERSAMATE® SERIES

100A SELECTION INFORMATION

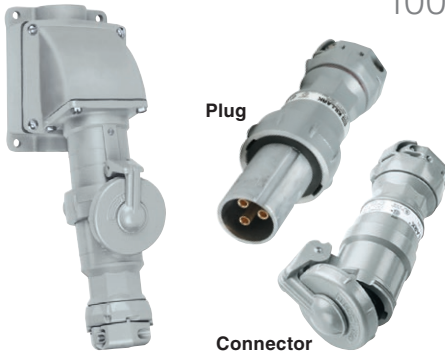

Plug

Connector

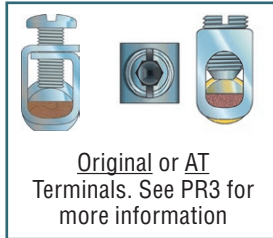

Original or AT
Terminals. See PR3 for
more information

• 100 Amp 600VAC/250VDC; 50-400 Hertz
NEMA 3, 4, 4X[Ⓛ]

Wire Range

Regular Stranding: #4 - #2 original style or "AT" type
(Includes Type P marine)
Extra flex: #4 - #2 original style or "AT" type

UL File No. E10757 CB Certified File No. LR111846

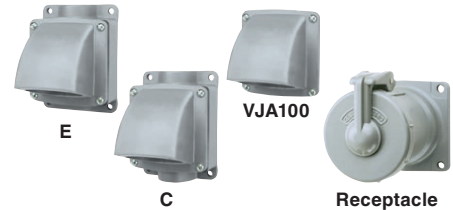

Receptacle

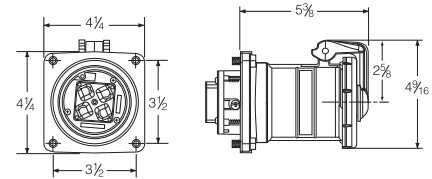

Plug

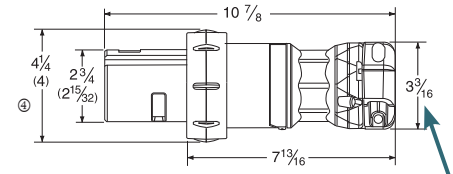

VersaMate® clamps provide a firm fit for one plug (or connector) over a wide range of cable diameters (competitors often need two - requiring additional sizing decisions).

Connector

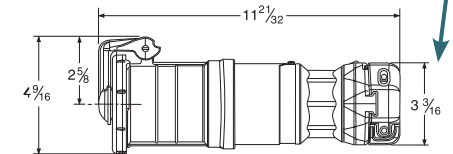

FEATURES-SPECIFICATIONS

100 AMP PLUGS & CONNECTORS						
GROUND STYLE	CIRCUIT	GROMMET RANGE	CATALOG NUMBER			
			PLUG		CONNECTOR	
			ORIG.	AT	ORIG.	AT
Style I	2W2P	.88 - 1.68 IN	VP10277	VP1022	VPR10257	VPR1022
	3W3P	.88 - 1.68 IN	VP10377	VP1033	VPR10357	VPR1033
	4W4P	.88 - 1.68 IN	VP10477	VP1044	VPR10457	VPR1044
Style II	2W3P	.88 - 1.68 IN	VP10387	VP1023	VPR10367	VPR1023
	3W4P	.88 - 1.68 IN	VP10487	VP1034	VPR10467	VPR1034

MODIFICATIONS*	
CATALOG NUMBER	DESCRIPTION
S39	Reverse service for receptacles, plugs & connectors
S37	Polarization for receptacles, plugs & connectors

* See page PR3 for more information on these options.

100 AMP RECEPTACLES & BACK BOXES							
GROUND STYLE	CIRCUIT	CATALOG NUMBER					
		E [Ⓛ] TYPE DEAD END		C [Ⓛ] TYPE FEED THRU		RECEPTACLE ONLY	
		ORIG.	AT	ORIG.	AT	ORIG.	AT
Style I	2W2P	VR1021E5	VR1022E5	VR1021C5	VR1022C5	VR1021	VR1022
	3W3P	VR1031E5	VR1033E5	VR1031C5	VR1033C5	VR1031	VR1033
	4W4P	VR1041E5	VR1044E5	VR1041C5	VR1044C5	VR1041	VR1044
Style II	2W3P	VR1032E5	VR1023E5	VR1032C5	VR1023C5	VR1032	VR1023
	3W4P	VR1042E5	VR1034E5	VR1042C5	VR1034C5	VR1042	VR1034
Splice box only [Ⓛ]		VJ57	VJ57	VJC57	VJC57	VJA100*	VJA100*

* Angle adapter only

- Ⓛ Components are interchangeable & UL classified with other UL1686 configured devices (when installed in accordance with instructions furnished with device). Assemblies containing components from other manufacturers would have the NEMA type rating of the lowest rated device.
- Ⓛ 100 Amp Back Boxes are available in 1", 1-1/4", 1-1/2" & 2" conduit sizes. Size listed above is 1-1/2". For other available sizes, change the BOLD "5" in either the assembly or box only number as follows: **3=1"**, **4=1-1/4"**, **5=1-1/2"**, **6=2"**. Assembly catalog numbers are listed for ease of ordering or specification and devices are shipped as components.
- Ⓛ 100 Amp Boxes & Adapters also fit 60 Amp receptacles. Adapter only can be used to attach receptacle at an angle to a standard sheet metal box.
- Ⓛ Dimensions in () are 3 pole devices; balance are 4 pole.

Back Box Dimensions

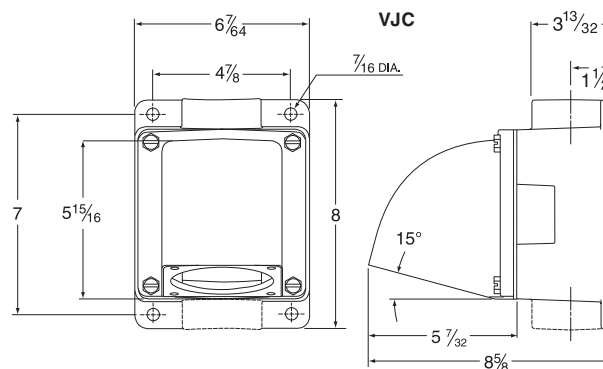

Feed through style shown

CONNECTORS

VERSAMATE® SERIES



150A SELECTION INFORMATION



**ALLEN
TERMINALS**



Plug



Connector

• 150 Amp 600VAC/250VDC; 50-400 hertz
NEMA 3, 4, 4X^①

Wire Range

Building #2-2/0
(Includes Type P marine)
Extra Flex #2-2/0

UL US File No. E10757
SP



E



C



Receptacle

FEATURES-SPECIFICATIONS

150 AMP PLUGS & CONNECTORS				
GROUND STYLE	CIRCUIT	GROMMET RANGE	CATALOG NUMBER	
			PLUG	CONNECTOR
Style I	4W4P	.88 - 1.91 IN	VPA15044	VCA15044
Style II	3W4P	.88 - 1.91 IN	VPA15034	VCA15034

MODIFICATIONS*	
CATALOG NUMBER	DESCRIPTION
S39	Reverse service for receptacles, plugs & connectors
S37	Polarization for receptacles, plugs & connectors

* See page PR3 for more information on these options.

150 AMP RECEPTACLES & BACK BOXES				
GROUND STYLE	CIRCUIT	CATALOG NUMBER		
		E ^② TYPE DEAD END	C ^② TYPE FEED THRU	RECEPTACLE ONLY
Style I	4W4P	VRA15044E6	VRA15044C6	VRA15044
Style II	3W4P	VRA15034E6	VRA15034C6	VRA15034
Splice box only w/ adapter ^③		VJ67	VJC67	VJA100*

* Angle adapter only

- ① Components are interchangeable & UL classified with Appleton® Powertite® (when installed in accordance with instructions furnished with device). Assemblies containing components from other manufacturers would have the NEMA type rating of the lowest rated device.
- ② 150 Amp Back Boxes are available in 1-1/4", 1-1/2" & 2" conduit sizes. Size listed above is 2". For other available sizes, change the BOLD "6" in either the assembly or box only number as follows: **4**=1-1/4", **5**=1-1/2", **6**=2". Assembly catalog numbers are listed for ease of ordering or specification and devices are shipped as components.
- ③ 100/150 Amp Boxes & Adapters also fit 60 Amp receptacles. Adapter-only can be used to attach receptacle at an angle to a standard sheet metal box.

Back Box Dimensions

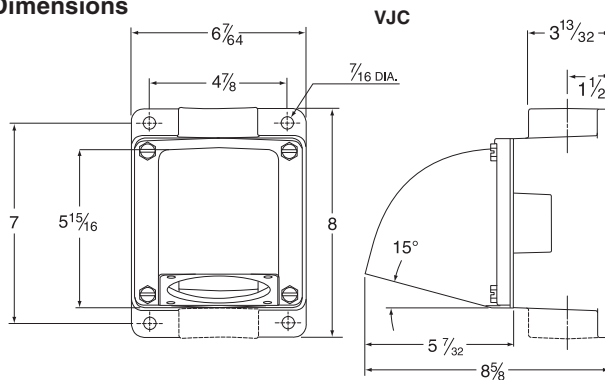

Feed through style shown

Receptacle

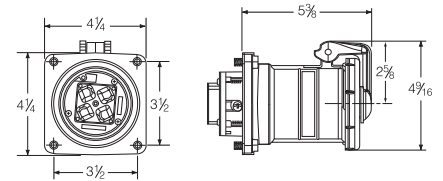

Plug

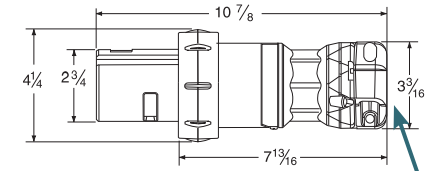

VersaMate® clamps provide a firm fit for one plug (or connector) over a wide range of cable diameters (competitors often need two - requiring additional sizing decisions).

Connector

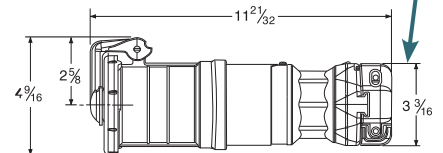



VERSAMATE® SERIES

200A SELECTION INFORMATION



**ALLEN
TERMINALS**



Plug



Connector

• 200 Amp 600VAC/250VDC; 50-400 Hertz
NEMA 3, 4, 4X①

Wire Range

Regular Stranding: #1 - 250

(Includes Type P marine)

Extra flex: #1 - 250 (.653 max conductor diameter)

UL File No. E10757 NSF Certified File No. LR111846



E



C



Receptacle

FEATURES-SPECIFICATIONS

200 AMP PLUGS & CONNECTORS				
GROUND STYLE	CIRCUIT	GROMMET RANGE	CATALOG NUMBER	
			PLUG	CONNECTOR
Style I	3W3P	1.0 - 2.5 IN	VP203512	VPR203112
	4W4P	1.0 - 2.5 IN	VP204513	VPR204113
Style II	2W3P	1.0 - 2.5 IN	VP203612	VPR203212
	3W4P	1.0 - 2.5 IN	VP204612	VPR204212

MODIFICATIONS*	
CATALOG NUMBER	DESCRIPTION
S39Ⓞ	Reverse service for receptacles, plugs & connectors
S37	Polarization for receptacles, plugs & connectors

* See page PR3 for more information on these options.

200 AMP RECEPTACLES & BACK BOXES				
GROUND STYLE	CIRCUIT	CATALOG NUMBER		
		EⓄ TYPE DEAD END	CⓄ TYPE FEED THRU	RECEPTACLE ONLY
Style I	3W3P	VR20312E6	VR20312C7	VR20312
	4W4P	VR20412E6	VR20412C7	VR20412
Style II	2W3P	VR20322E6	VR20322C7	VR20322
	3W4P	VR20422E6	VR20422C7	VR20422
Splice box only w/ adapterⓄⓅ		VJ78	VJC78	Angle adapter only VJA200

① Components are intermateable & UL classified with Appleton® Powertite® or Crouse-Hinds® Arktite® devices (when installed in accordance with instructions furnished with device. Assemblies containing components from other manufacturers would have the NEMA type rating of the lowest rated device.

Ⓞ 200 Amp dead-end Back Boxes are available in sizes 1-1/2", 2" & 2-1/2" conduit sizes. Dead-end box shown is 2". For other available dead-end box sizes, change the BOLD "6" in either the dead-end assembly or box only number as follows: **5**=1-1/2", **6**=2", **7**=2-1/2". Feed through boxes are available in 2-1/2"; use "R" series adapters as required for smaller sizes (sold separately). Assembly catalog numbers are listed for ease of ordering or specification and devices are shipped as components.

Ⓟ Adapter-only can be used to attach receptacle at an angle to a standard sheet metal box.

Ⓠ Dimensions in () are 3 pole devices; balance are 4 pole.

Ⓡ 200A 3W4P Reverse Service configured "W" Series and VersaMate® are not intermateable. However, the VersaMate VR20422-S39 receptacle ships with instructions to permanently convert for use with existing PW-6402X SU39 plugs. Factory only configured plugs to fit old RW64C-SU39 receptacles may be ordered as VP-PW64026 SU39.

NOTE: 200A VersaMate receptacle lids secure with wingnuts for N4X environments when not in use. VersaMate plugs secure with wingnuts and/or lock-ring collar. This exclusive dual method allows retention of competitive plugs that use either wingnuts or a lock-ring collar.

Receptacle

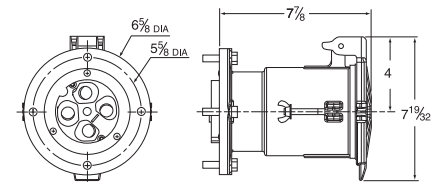

Plug

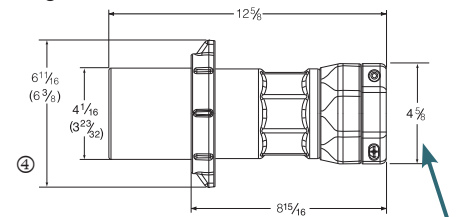

VersaMate® clamps provide a firm fit for one plug (or connector) over a wide range of cable diameters (competitors often need two – requiring additional sizing decisions).

Connector

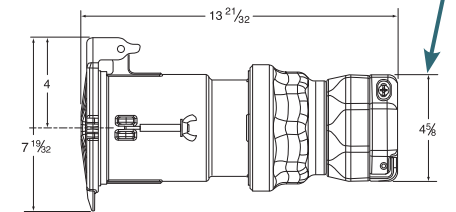

Back Box Dimensions

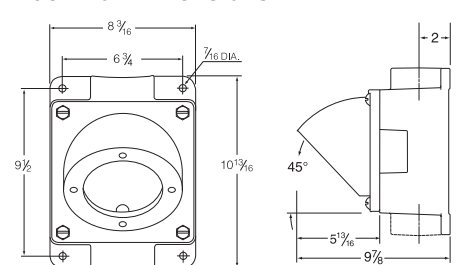

VJC



INTRODUCTION TO RMP® II SERIES



RMP® II Series
Female Panel Mounted
Receptacle



RMP® II Series
Male Panel Mounted
Receptacle

Typical Applications

To move a land drilling rig, it must be disassembled into components small enough to fit on standard highway trucks. Given the need to complete the moves as quickly as possible, it is necessary to have a means of quickly and safely connecting the large electrical cables which power the many components of the rig.

RigPower's RMP® II Series (single pole) connectors are designed specifically with the requirements of the drilling industry in mind. These products are designed to deliver up to 1,000 Volts AC or DC and up to 1,135 Amps of continuous power in the most extreme conditions. Typical applications are: the connection of power from generator sets to Switchgear or SCR (silicon-controlled rectifiers) controls, from the control house to traction motors, mud pumps, draw-works, rotary tables, cement pumps and top drives.

Configurations

The RMP® II Series connectors are available in all configurations of male and female connectors. Typical configurations are shown below.

POWER SIDE	EQUIPMENT	USE
Male Panel Mount Receptacle	Female Plug	AC or DC output side of panel
Male Plug	Female Plug	In-line cable to cable connection
Male Plug	Female Panel Mount Receptacle	AC Power to switch-gear

Installation

The simple design of the RMP® II Series allows the connectors to be mated and unmated without the use of tools.

Type P Cables

The RMP® II Series connectors are designed to work in conjunction with the latest generation of Type P drilling cables, per IEEE 45. Cable accommodations are 4/0 MCM to 777 MCM.

AMPACITY RATINGS IN 40° AMBIENT		
CABLE SIZE	90°	125°
4/0 MCM	364 AMPS	451 AMPS
262 MCM	428 AMPS	566 AMPS
313 MCM	513 AMPS	636 AMPS
373 MCM	548 AMPS	669 AMPS
444 MCM	642 AMPS	796 AMPS
535 MCM	724 AMPS	898 AMPS
646 MCM	814 AMPS	1009 AMPS
777 MCM	916 AMPS	1135 AMPS

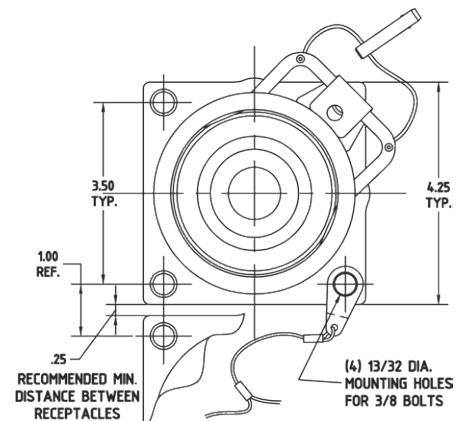

Available Colors





RMP® II SERIES

RMP® II Panel Mount Housings

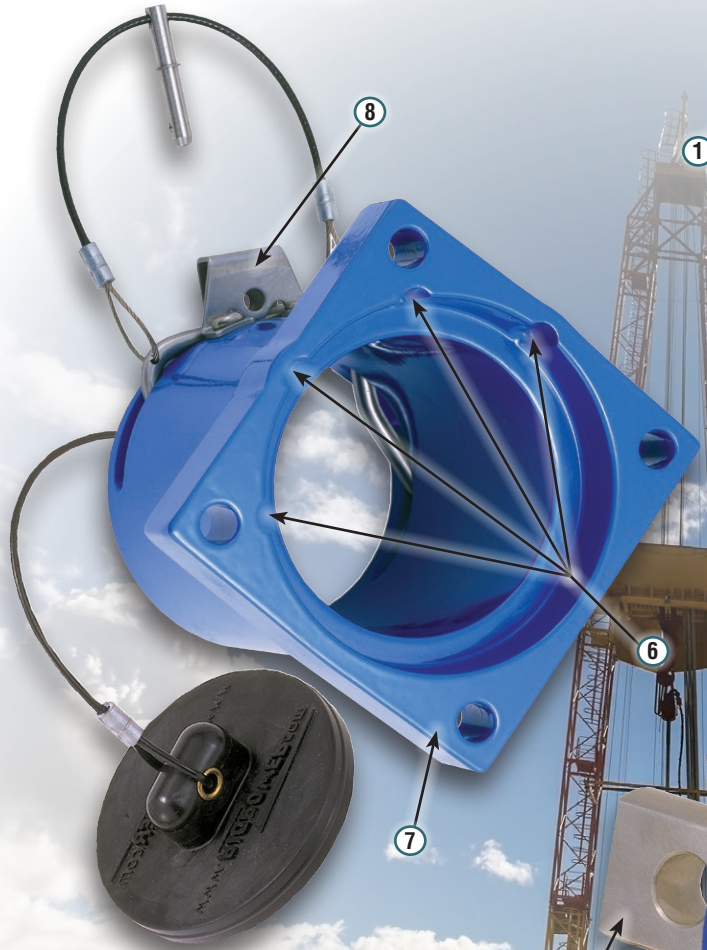

RMP® II Female Receptacles

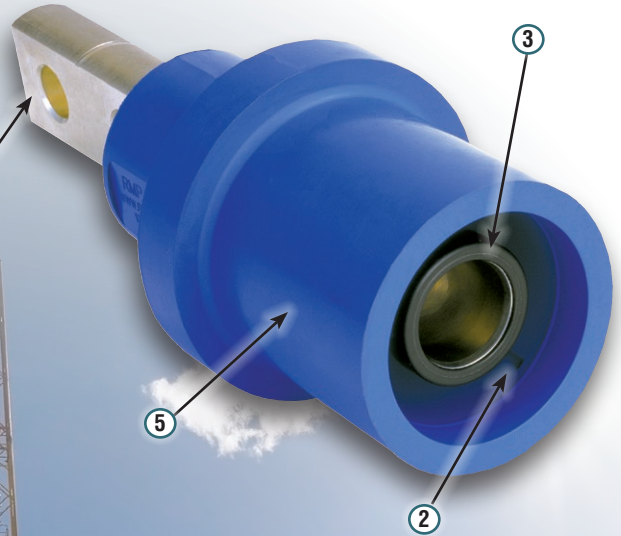

RMP® II Male Receptacles

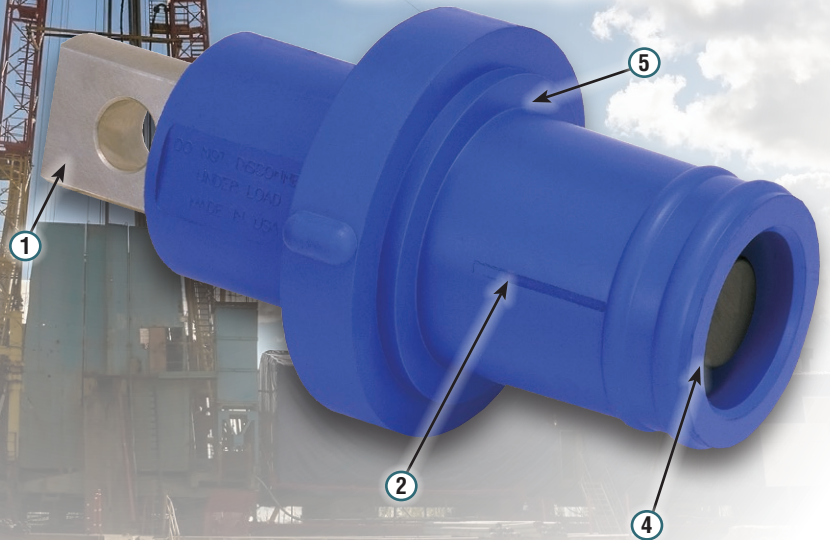

Female Contacts

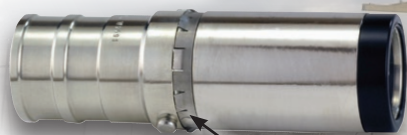

Male Contacts

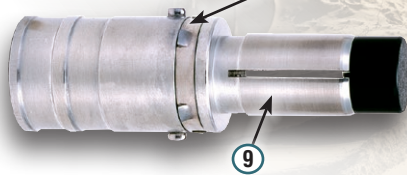

10

9



RMP® II SERIES RECEPTACLES



RMP® II Series
Female Panel Mounted
Receptacle



RMP® II Series
Male Panel Mounted
Receptacle

OSHA 1910 compliant
-40°C to +55°C ambient temperature
NEMA 3R
1000 Volts AC/DC
400-1135 Amps
Class 1 Div.2



FEATURES-SPECIFICATIONS

Receptacles

- 1 **Buss Bar** – Buss Bar termination is provided on all panel mounted receptacles. Receptacles are available with Single or Double Hole Buss Bar Styles.
- 2 **Molded vacuum release groove** – Designed into all insulators which aids in assembly and disassembly of connectors while allowing NEMA 3R rated seal.
- **Patented Design of Connectors**
 - » The inherent design of the connectors is such that the electrical contacts are shrouded by the rubber insulators. BOTH the male and female have a dead front end to protect operators from shock hazard. Connectors are rated at 1000 volts AC or DC with the ability to withstand intermittent surges up to 1,300 Amps.
 - » 3 **Female Receptacle** – Female Contact with Dead Front Ring, provides increased safety by helping to prevent accidental contact.
 - » 4 **Male Receptacle** – Duplex plated high conductivity copper with self adjusting contact force. Allows increased contact surface area and prevents collection of debris.

- 5 **Rubber** – Made with a Proprietary Synthetic Thermoset Rubber with “Self-Lubricating” technology. The receptacles are resistant to oil, mud, sea water and petroleum products. Material is designed to provide weatherproof service in a variety of demanding environments.
- **Temperature Ratings**
 - » RigPower’s RMP® II receptacles are designed to operate in extreme temperatures, (-40°C to +55°C ambient).

Panel Mount Housings

- 6 **Buss Bar Positions** – In addition to the traditional alignment of the receptacle buss bars, RMP® II Receptacle Housing offers four alignment cutouts which allows positioning of the buss bar at 45° left or 45° right to ease cable routing.
- 7 **Panel Mount Housing**
- 8 **“Snap Action” locking mechanism** – RigPower designed, it is located at a 45° degree angle and can withstand the most intensive vibration. Included is a safety pin and a pull lanyard to disengage the mechanism easily. Unique diameter of locking pin opening and available pad lock enhances safety.

Contacts

- **Female Contact**
 - » Duplex plated high conductivity copper with Dead Front Ring. Provides increased safety by helping to prevent accidental contact.
- **Male Contact**
 - » Duplex plated high conductivity copper with self adjusting contact force. Allows increased contact pressure and prevents collection of debris.
 - » 9 **New contrast profile** allows increased contact pressure with reduced insertion force.
- 10 **Six flared locking clasps** – The heavy spring stainless steel locking band on BOTH the male and female contacts has SIX flared locking clasps which provides a more permanent mounting connection.
- Termination method is double crimp style for cable mounted plug.

RMP® II PANEL MOUNT RECEPTACLES					HOUSINGS
COLOR	SINGLE HOLE MALE	DOUBLE HOLE MALE	SINGLE HOLE FEMALE	DOUBLE HOLE FEMALE	CATALOG NO.
Black	RMP-PMR-1M-BK	RMP-PMR-2M-BK	RMP-PMR-1F-BK	RMP-PMR-2F-BK	RMP-PMR-BK
Blue	RMP-PMR-1M-BL	RMP-PMR-2M-BL	RMP-PMR-1F-BL	RMP-PMR-2F-BL	RMP-PMR-BL
Brown	RMP-PMR-1M-BR	RMP-PMR-2M-BR	RMP-PMR-1F-BR	RMP-PMR-2F-BR	RMP-PMR-BR
Green	RMP-PMR-1M-G	RMP-PMR-2M-G	RMP-PMR-1F-G	RMP-PMR-2F-G	RMP-PMR-G
Gray	RMP-PMR-1M-GY	RMP-PMR-2M-GY	RMP-PMR-1F-GY	RMP-PMR-2F-GY	RMP-PMR-GY
Orange	RMP-PMR-1M-OR	RMP-PMR-2M-OR	RMP-PMR-1F-OR	RMP-PMR-2F-OR	RMP-PMR-OR
Purple	RMP-PMR-1M-P	RMP-PMR-2M-P	RMP-PMR-1F-P	RMP-PMR-2F-P	RMP-PMR-P
Red	RMP-PMR-1M-R	RMP-PMR-2M-R	RMP-PMR-1F-R	RMP-PMR-2F-R	RMP-PMR-R
White	RMP-PMR-1M-W	RMP-PMR-2M-W	RMP-PMR-1F-W	RMP-PMR-2F-W	RMP-PMR-W
Yellow	RMP-PMR-1M-Y	RMP-PMR-2M-Y	RMP-PMR-1F-Y	RMP-PMR-2F-Y	RMP-PMR-Y

RMP® II CONTACTS		
	MALE CONTACTS CATALOG NUMBER	FEMALE CONTACTS CATALOG NUMBER
Cable Size 4/0 MCM Through 777 MCM	RMP-C-4/ØM	RMP-C-4/ØF
	RMP-C-262M	RMP-C-262F
	RMP-C-3M	RMP-C-3F
	RMP-C-373M	RMP-C-373F
	RMP-C-4M	RMP-C-4F
	RMP-C-5M	RMP-C-5F
	RMP-C-6M	RMP-C-6F
	RMP-C-7M	RMP-C-7F





RMP® II SERIES

RMP® II Female Plugs

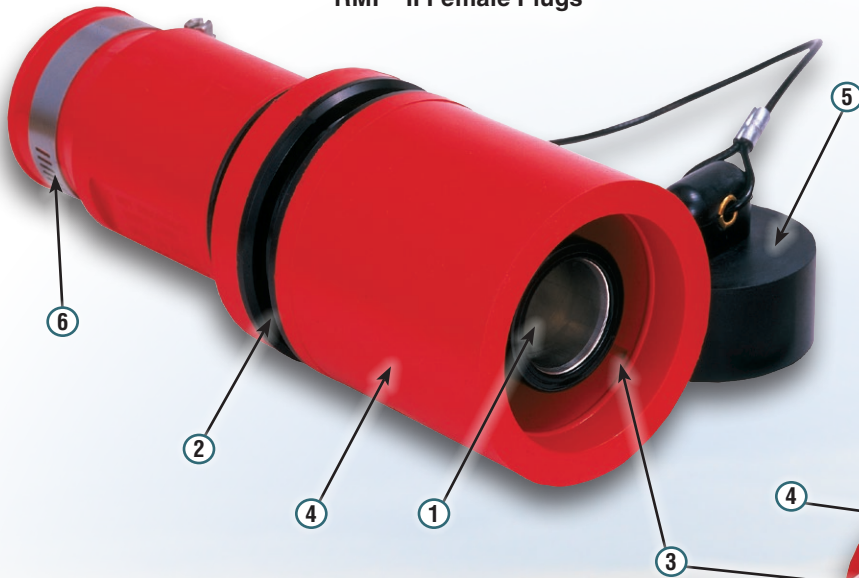

RMP® II Male Plugs



RMP® II In-line Connection

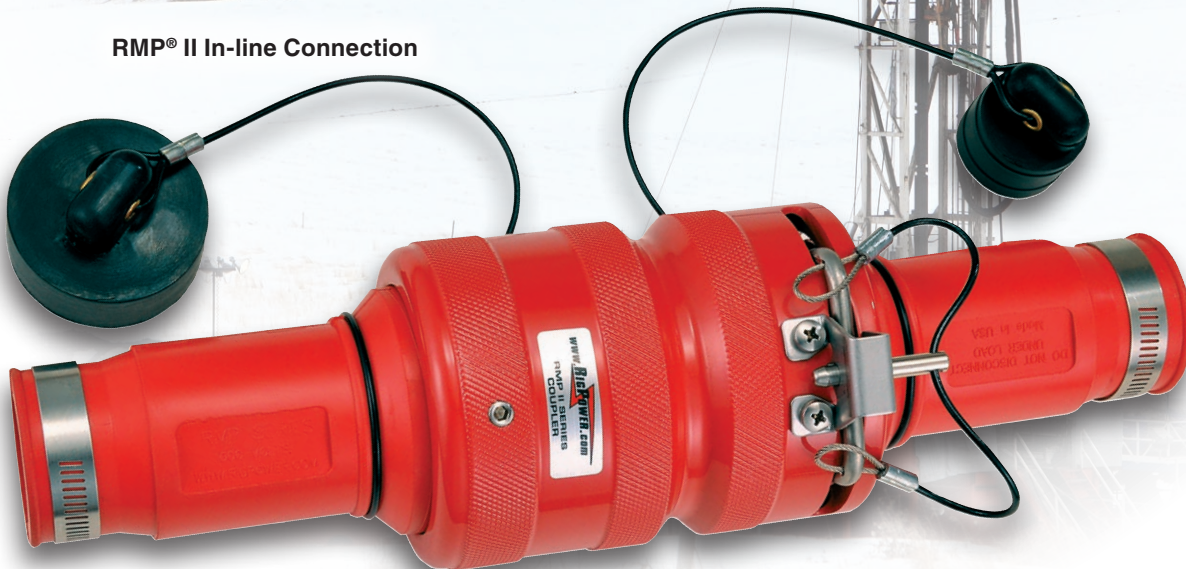



RMP® II SERIES PLUGS

RMP® II Female Plugs



RMP® II Male Plugs



FEATURES-SPECIFICATIONS

Insulators

The rubber insulators can be bonded to the cables by vulcanization.

RMP® II Plugs

The inherent design of the plugs allows for the electrical contacts to be shrouded by the rubber insulators. **BOTH** the male and female have a Patented dead front end to help protect operators from shock hazard. The plugs are rated at 1000 volts AC or DC with the ability to withstand intermittent surges up to 1,300 Amps.

- 1 **Dead Front End**
- 2 **Locking ring** – It is powder coated black to prevent unnecessary corrosion thus enhancing the life of the product.

- 3 **Molded vacuum release groove** – Designed into all insulators which aids in assembly and disassembly of connectors while allowing NEMA 3R rated seal.
- 4 **Rubber** – Made with a Proprietary Synthetic Thermoset Rubber (not Thermoplastic) with “Self-Lubricating” technology. The insulators are resistant to oil, mud, sea water and petroleum products and are designed to provide weatherproof service in a variety of demanding environments. Correctly assembled, the connectors provide safe trouble-free operation in the most extreme working conditions.
- 5 **Rubber Cap** – included
- 6 **Stainless Steel Hose Clamp** – provided

RMP® II INSULATORS		
COLOR	MALE INSULATORS	FEMALE INSULATORS
Black	RMP-CMP-M-BK	RMP-CMP-F-BK
Blue	RMP-CMP-M-BL	RMP-CMP-F-BL
Brown	RMP-CMP-M-BR	RMP-CMP-F-BR
Green	RMP-CMP-M-G	RMP-CMP-F-G
Gray	RMP-CMP-M-GY	RMP-CMP-F-GY
Orange	RMP-CMP-M-OR	RMP-CMP-F-OR
Purple	RMP-CMP-M-P	RMP-CMP-F-P
Red	RMP-CMP-M-R	RMP-CMP-F-R
White	RMP-CMP-M-W	RMP-CMP-F-W
Yellow	RMP-CMP-M-Y	RMP-CMP-F-Y

RMP® II CABLE END ASSEMBLIES - MALE PLUGS								
COLOR	4/0 CONTACT	262 CONTACT	313 CONTACT	373 CONTACT	444 CONTACT	535 CONTACT	646 CONTACT	777 CONTACT
Black	RMP-CMP-4/0M-BK	RMP-CMP-262M-BK	RMP-CMP-3M-BK	RMP-CMP-373M-BK	RMP-CMP-4M-BK	RMP-CMP-5M-BK	RMP-CMP-6M-BK	RMP-CMP-7M-BK
Blue	RMP-CMP-4/0M-BL	RMP-CMP-262M-BL	RMP-CMP-3M-BL	RMP-CMP-373M-BL	RMP-CMP-4M-BL	RMP-CMP-5M-BL	RMP-CMP-6M-BL	RMP-CMP-7M-BL
Brown	RMP-CMP-4/0M-BR	RMP-CMP-262M-BR	RMP-CMP-3M-BR	RMP-CMP-373M-BR	RMP-CMP-4M-BR	RMP-CMP-5M-BR	RMP-CMP-6M-BR	RMP-CMP-7M-BR
Green	RMP-CMP-4/0M-G	RMP-CMP-262M-G	RMP-CMP-3M-G	RMP-CMP-373M-G	RMP-CMP-4M-G	RMP-CMP-5M-G	RMP-CMP-6M-G	RMP-CMP-7M-G
Gray	RMP-CMP-4/0M-GY	RMP-CMP-262M-GY	RMP-CMP-3M-GY	RMP-CMP-373M-GY	RMP-CMP-4M-GY	RMP-CMP-5M-GY	RMP-CMP-6M-GY	RMP-CMP-7M-GY
Orange	RMP-CMP-4/0M-OR	RMP-CMP-262M-OR	RMP-CMP-3M-OR	RMP-CMP-373M-OR	RMP-CMP-4M-OR	RMP-CMP-5M-OR	RMP-CMP-6M-OR	RMP-CMP-7M-OR
Purple	RMP-CMP-4/0M-P	RMP-CMP-262M-P	RMP-CMP-3M-P	RMP-CMP-373M-P	RMP-CMP-4M-P	RMP-CMP-5M-P	RMP-CMP-6M-P	RMP-CMP-7M-P
Red	RMP-CMP-4/0M-R	RMP-CMP-262M-R	RMP-CMP-3M-R	RMP-CMP-373M-R	RMP-CMP-4M-R	RMP-CMP-5M-R	RMP-CMP-6M-R	RMP-CMP-7M-R
White	RMP-CMP-4/0M-W	RMP-CMP-262M-W	RMP-CMP-3M-W	RMP-CMP-373M-W	RMP-CMP-4M-W	RMP-CMP-5M-W	RMP-CMP-6M-W	RMP-CMP-7M-W
Yellow	RMP-CMP-4/0M-Y	RMP-CMP-262M-Y	RMP-CMP-3M-Y	RMP-CMP-373M-Y	RMP-CMP-4M-Y	RMP-CMP-5M-Y	RMP-CMP-6M-Y	RMP-CMP-7M-Y

RMP® II CABLE END ASSEMBLIES - FEMALE PLUGS								
COLOR	4/0 CONTACT	262 CONTACT	313 CONTACT	373 CONTACT	444 CONTACT	535 CONTACT	646 CONTACT	777 CONTACT
Black	RMP-CMP-4/0F-BK	RMP-CMP-262F-BK	RMP-CMP-3F-BK	RMP-CMP-373F-BK	RMP-CMP-4F-BK	RMP-CMP-5F-BK	RMP-CMP-6F-BK	RMP-CMP-7F-BK
Blue	RMP-CMP-4/0F-BL	RMP-CMP-262F-BL	RMP-CMP-3F-BL	RMP-CMP-373F-BL	RMP-CMP-4F-BL	RMP-CMP-5F-BL	RMP-CMP-6F-BL	RMP-CMP-7F-BL
Brown	RMP-CMP-4/0F-BR	RMP-CMP-262F-BR	RMP-CMP-3F-BR	RMP-CMP-373F-BR	RMP-CMP-4F-BR	RMP-CMP-5F-BR	RMP-CMP-6F-BR	RMP-CMP-7F-BR
Green	RMP-CMP-4/0F-G	RMP-CMP-262F-G	RMP-CMP-3F-G	RMP-CMP-373F-G	RMP-CMP-4F-G	RMP-CMP-5F-G	RMP-CMP-6F-G	RMP-CMP-7F-G
Gray	RMP-CMP-4/0F-GY	RMP-CMP-262F-GY	RMP-CMP-3F-GY	RMP-CMP-373F-GY	RMP-CMP-4F-GY	RMP-CMP-5F-GY	RMP-CMP-6F-GY	RMP-CMP-7F-GY
Orange	RMP-CMP-4/0F-OR	RMP-CMP-262F-OR	RMP-CMP-3F-OR	RMP-CMP-373F-OR	RMP-CMP-4F-OR	RMP-CMP-5F-OR	RMP-CMP-6F-OR	RMP-CMP-7F-OR
Purple	RMP-CMP-4/0F-P	RMP-CMP-262F-P	RMP-CMP-3F-P	RMP-CMP-373F-P	RMP-CMP-4F-P	RMP-CMP-5F-P	RMP-CMP-6F-P	RMP-CMP-7F-P
Red	RMP-CMP-4/0F-R	RMP-CMP-262F-R	RMP-CMP-3F-R	RMP-CMP-373F-R	RMP-CMP-4F-R	RMP-CMP-5F-R	RMP-CMP-6F-R	RMP-CMP-7F-R
White	RMP-CMP-4/0F-W	RMP-CMP-262F-W	RMP-CMP-3F-W	RMP-CMP-373F-W	RMP-CMP-4F-W	RMP-CMP-5F-W	RMP-CMP-6F-W	RMP-CMP-7F-W
Yellow	RMP-CMP-4/0F-Y	RMP-CMP-262F-Y	RMP-CMP-3F-Y	RMP-CMP-373F-Y	RMP-CMP-4F-Y	RMP-CMP-5F-Y	RMP-CMP-6F-Y	RMP-CMP-7F-Y





RMP® II SERIES

RMP® II Bulkhead Mounted Coupler

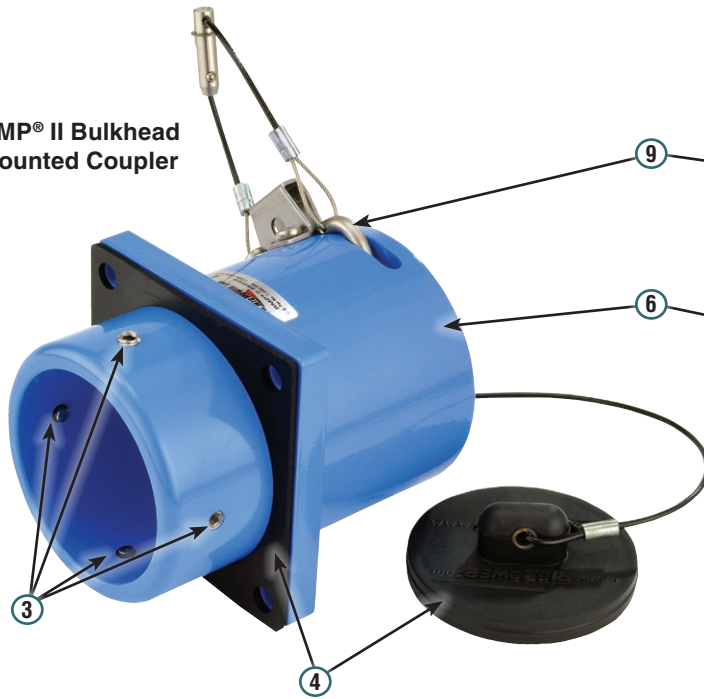

RMP® II Couplers

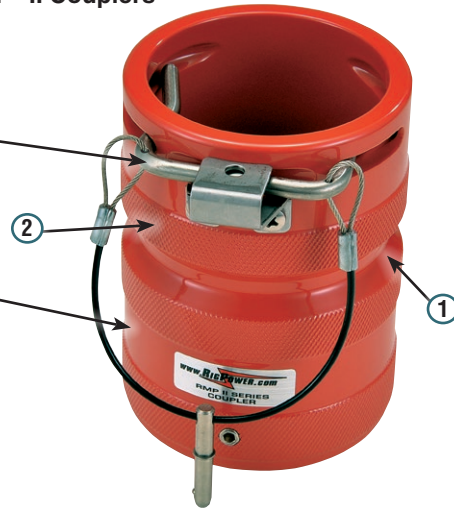

Available Colors



FEATURES-SPECIFICATIONS

RMP® II Couplers

Machined copper-free aluminum alloy. Required when making In-line cable connections. Securely holds male and female plugs together when the mounting screws and “Snap Action” locking mechanism are engaged.

1 Channel Groove – Channel Groove allows for permanent mounting of coupler to structure using a U-clamp. Deep groove prevents coupler from vibrating out of location.

- 2 Easy Handling Design** – The RigPower RMP® II Coupler is more robust than other manufacturers’ designs. The coupler has deeply knurled bands which allow for easy handling when mating plugs.
- 6 Powdered Coated Color Coded** – Powdered Coated Color Coded In-line couplers for rapid phase identification and increased personnel safety.
- 9 “Snap Action” locking mechanism** – RigPower designed “Snap Action” locking mechanism (located on each coupler) can withstand the most intensive vibration. Includes a safety pin and has a pull lanyard to disengage the mechanism easily.

RMP® II COUPLERS

RMP® II COUPLERS	
CATALOG NUMBER	
	RMP-CMR-BK
	RMP-CMR-BL
	RMP-CMR-BR
	RMP-CMR-G
	RMP-CMR-GY
	RMP-CMR-OR
	RMP-CMR-P
	RMP-CMR-R
	RMP-CMR-W
	RMP-CMR-Y
	RMP-CMR-AL

RMP® II Bulkhead Mounted Coupler

The bulkhead Mounted Coupler is designed for locations where a closed back is desired on a panel mounted receptacle. When the inside of an enclosure is either exposed to high moisture or dirt levels, or where safe personnel access is required, the BMC provides the Bulkhead mounting of a standard RMP® II receptacle with the environmental sealing of an RMP® II series plug.

- 3 Four hex screws** – Securely hold plug in place
- 4 Gasket and Safety Cap Provided**
- 6 Powdered Coated Color Coded** – Powder Coated Color Coded bulkhead mounted coupler for rapid phase identification and increased personnel safety.
- 9 “Snap Action” locking mechanism**

BULKHEAD MOUNTED COUPLER

BULKHEAD MOUNTED COUPLER	
COLOR	CATALOG NUMBER
Black	RMP-BMC-BK
Blue	RMP-BMC-BL
Brown	RMP-BMC-BR
Green	RMP-BMC-G
Gray	RMP-BMC-GY
Orange	RMP-BMC-OR
Purple	RMP-BMC-P
Red	RMP-BMC-R
White	RMP-BMC-W
Yellow	RMP-BMC-Y



RMP® II COUPLERS AND ACCESSORIES

Complies with NFPA 70 and OSHA 1910 lockout requirements

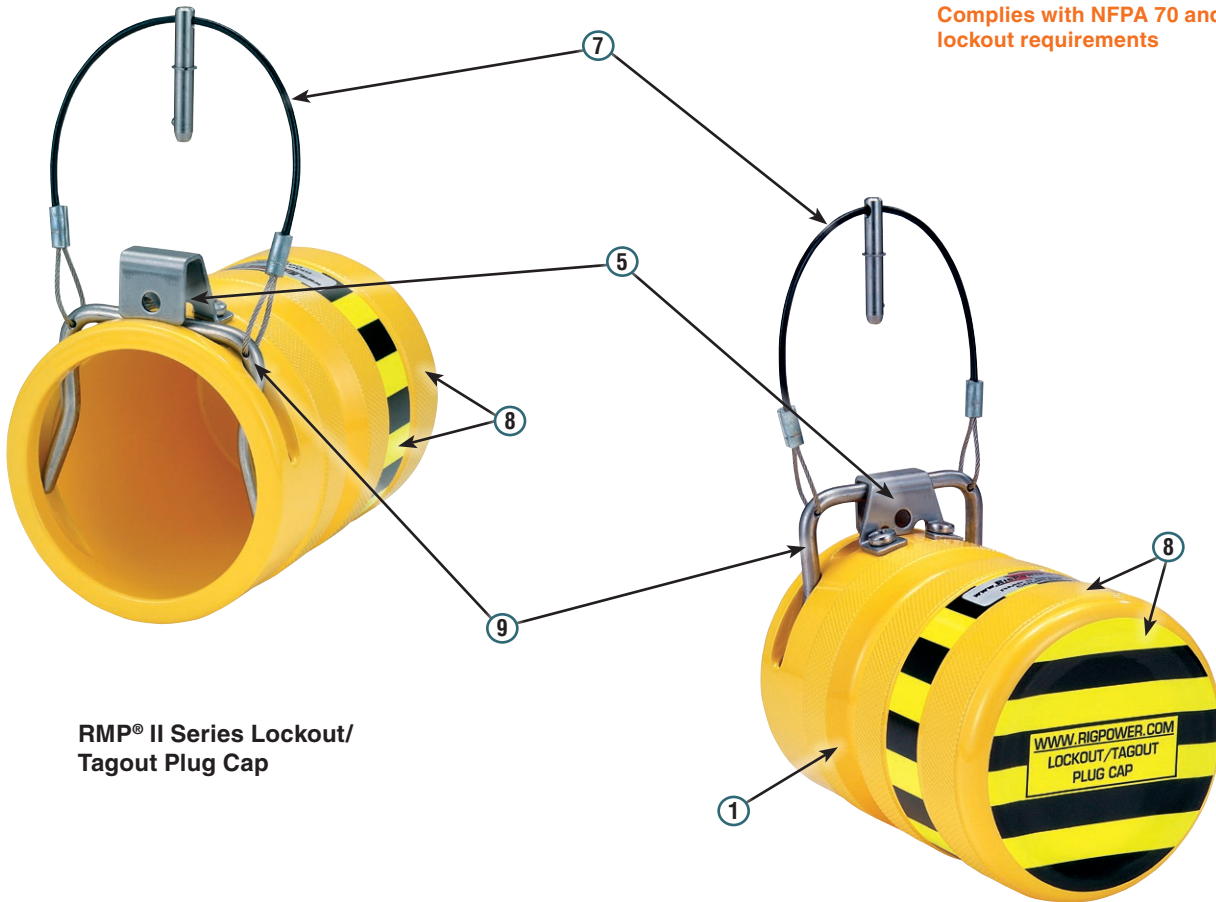

RMP® II Series Lockout/Tagout Plug Cap

FEATURES-SPECIFICATIONS

RMP® II Series Lockout/Tagout Plug Cap

- Complies with NFPA 70 and OSHA 1910 lockout requirements
 - Provides quick and secure lockout of electrical cables
 - The Safety Cap allows for the use of installed RMP® II insulator caps for a dust free and water tight closure when encased
- 1 Channel Groove** – Strategically positioned Channel Groove allows for permanent mounting of Lockout/Tagout Plug Cap to structure using a U-clamp. The deep Channel Groove prevents Lockout/Tagout Plug Cap from vibrating out of position when mounted. Unique diameter of locking pin opening and available pad lock enhances safety. OSHA 1910 compliant.

- 5 Locking Hasp** – Locking hasp opening will accommodate standard OSHA compliant locks.
- 7 Pull Lanyard** – The pull lanyard is designed to easily disengage the mechanism and includes a safety pin for those operations which do not require Lockout/Tagout lock procedures.
- 8 Quick Identification**
- » Vibrant Yellow Epoxy Powder Coating surface with Black/Yellow safety markings for quick identification.
 - » Available only in yellow
- 9 “Snap Action” Locking Mechanism** – RigPower designed “Snap Action” locking mechanism can withstand the most intensive vibration and provides a quick and secure lockout of electrical cables.

RMP® II ACCESSORIES		
COLOR	CATALOG NO.	PART DESCRIPTION
Yellow Only	RMP-LOC-Y	Lockout/Tagout Plug Cap
X = Color	RMP-LOS-X	Single Pad Lock



POWER SWITCH RECEPTACLES AND ACCESSORIES

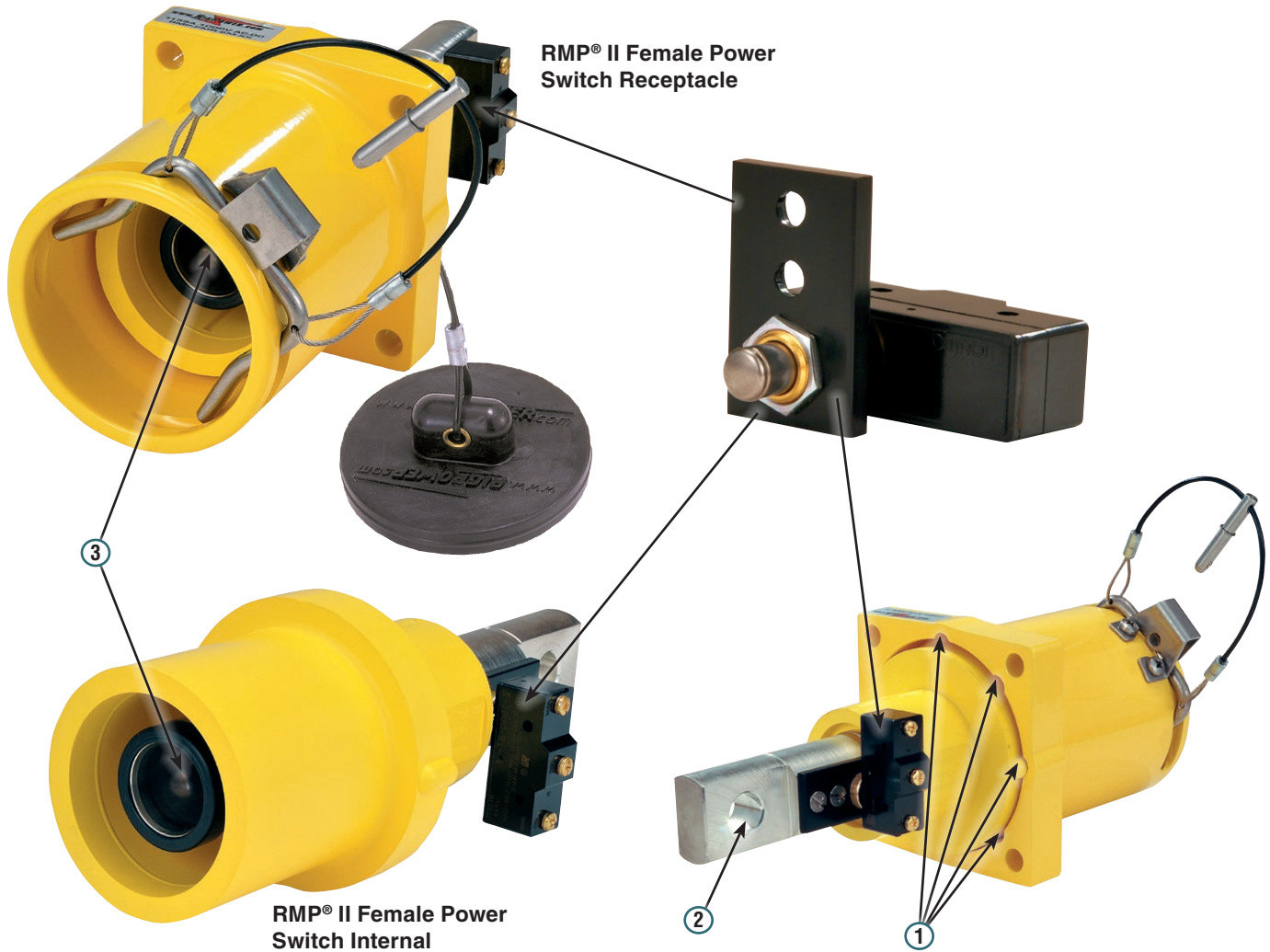

RMP® II Female Power Switch Receptacle

RMP® II Female Power Switch Internal

FEATURES-SPECIFICATIONS

RMP® II Female Power Switch Receptacle

This latest addition to the RMP® II line of advanced single pole electrical connectors will allow remote indication of disconnected power cables and will provide protection from single phasing on sensitive VFD systems.

- Available NO or NC contacts allow direct input to PLC logic for circuit isolation or control

1 Alignment Cutouts – Besides the traditional alignment of the receptacle buss bars, RMP® II Receptacle Housings offer four alignment cutouts which allows positioning of the buss bar at 45° left or 45° right to ease cable routing.

- 2 Buss Bar Style** – Power Switch Receptacles are available with single hole buss bar style termination only.
- 3 Secondary Switch** – The Female panel mount receptacle is equipped with a secondary switch to sense the presence of a connected male contact

NOTE: The Power Switch offers additional safety features; however, it is not intrinsically safe and is not designed to disconnect under load. Do not use Power Switch receptacles for power supply as any failure in the safety circuit would allow the female contact to be energized.

RMP® II Female Power Switch Internal

- The unit mounts in a standard RMP® II series housing and intermates with standard RMP® II series male cable ends
- The Power Switch connector is rated 900 amps at 1000 volts

FEMALE POWER SWITCH RECEPTACLE

COLOR	CATALOG NUMBER
Black	RMP-PMR-FPS-BK
Blue	RMP-PMR-FPS-BL
Brown	RMP-PMR-FPS-BR
Green	RMP-PMR-FPS-G
Gray	RMP-PMR-FPS-GY
Orange	RMP-PMR-FPS-OR
Purple	RMP-PMR-FPS-P
Red	RMP-PMR-FPS-R
White	RMP-PMR-FPS-W
Yellow	RMP-PMR-FPS-Y



POWER SWITCH RECEPTACLES AND ACCESSORIES

Flange Mounted Grounding Receptacle & Plug

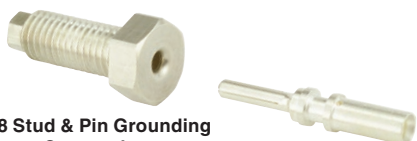

5/8 Stud & Pin Grounding Connection

Flange Mounted Grounding Receptacle & Plug

- Solid brass construction for highest conductivity
- Double cam design for vibration-proof connection
- Spring action slot that compensates for wear and extends service life

GROUNDING RECEPTACLES AND PLUGS	
CATALOG NO.	PART DESCRIPTION
RMP-FGP-4	Female Flange Mounted Grounding Plug
RMP-MGR	Male Flange Mounted Grounding Receptacle
RMP-FGR	Female Grounding Receptacle for 5/8 Stud
RMP-MGP-4	Male Grounding Pin for 5/8 Stud



Double Hole Lug

The industry's most robust Lug. Machined from solid copper bar stock.

- Termination method is double crimp style
- Crimping locators are designed into the base for ease of installation
- Uses the same crimping die sets as the RigPower RMP® II, Secure Mount®, Safe Stab®, MCC-1® and VFD-1™ series connectors

DOUBLE HOLE LUGS	
CATALOG NO.	PART DESCRIPTION
QS-535-L	535 MCM Double Hole Lug
QS-646-L	646 MCM Double Hole Lug
QS-777-L	777 MCM Double Hole Lug

DT-002 RMP® II Plug Disassembly Tool

- The only tool which allows easy field disassembly of male or female plugs.
- Allows field inspection of completed plugs for troubleshooting or for Quality Assurance inspections.
- Prevents damage to rubber insulator and injury to personnel.
- When tool is used properly, rubber insulator can be recovered for reuse.



RMP® II ACCESSORIES	
CATALOG NO.	PART DESCRIPTION
DT-002	Insulator Disassemble Tool



30° - 45° Reversible Locking Buss Bar Lug

The 30° or 45° Reversible Buss Bar Lug was created by RigPower to help eliminate the long bend radius that is inherent when using standard single or double hole crimp lugs. Compared to current single hole lugs, the Reversible Buss Bar Lug gives you mounting options no one else can. The lug's shoulder rests securely on the buss bar, preventing any rotation that may be caused from the weight of the cable tension or from equipment vibration. Reducing the bend radius provides for additional work space behind the SCR house panel and other panel mounted areas.

- Termination method is double crimp style
- Crimping locators are designed into the base for ease of installation
- Uses the same crimping die sets as the RigPower "RMP® II, Secure Mount®, Safe Stab®, MCC-1®, VFD-1™, HP20® and MC20" series connectors
- Made from Duplex Sn plated high conductivity copper

30°-45° REVERSIBLE LOCKING BUSS BAR LUGS

CATALOG NO.	PART DESCRIPTION
SL-535-AL	535 MCM 30°/45° Reversible Locking Buss Bar Lug
SL-646-AL	646 MCM 30°/45° Reversible Locking Buss Bar Lug
SL-777-AL	777 MCM 30°/45° Reversible Locking Buss Bar Lug



Pad Lock

- OSHA compliant locks available. Allows safe lock and tagout of receptacles and equipment. Individual and master key sets available. Sold in sets of five
- Can be used on Receptacles, In-line Couplers or Lockout/Tagout Plug Caps
- Available in ten (10) colors



LOS-X Five lock set - Individual Keys
LOM-X Five lock set - Individual Keys plus Master Key

For the crimping compression tool contact Burndy at www.burndy.com
Recommended Burndy Crimping Tool Part Number - Y750BH

RMP® II CRIMPING TOOLS/DIES		
CABLE SIZE	HEAD DIE CODE CRIMPING DIE CATALOG NUMBER	NUMBER OF CRIMPS
4/0	RP76	1
313 MCM	RP76	1
373 MCM	RP99H	2
444 MCM	RP99H	2
535 MCM	RP106H	2
646 MCM	RP115H	2
777 MCM	RP115H	2





HP20® SERIES





INTRODUCTION TO HP20® SERIES



HP20® Series
Male Receptacle



HP20® Series
Female Receptacle

Introduction

As each new drilling rig is designed, more and more equipment is added to allow deeper and faster drilling. However the size of the equipment that can be carried over the highways has a fixed limit. Thus the space that can be allowed for each component becomes smaller. RigPower's HP20® series connectors allow large cable sizes with smaller connector shells, providing tighter component spacing and maximizing the use of the available space.

The HP20® series is a new (patent pending) product exclusive to RigPower. It offers a small shell size 20 connector available in a full range of cable sizes from 4/0 to 777 DLO. This is the smallest connector on the market which will accept a 646 and 777 sized cable. It has a multilam contact system that is capable of carrying the full ampacity of 125 degree rated 777 cable. The HP20® series is available in a wide range of styles and is stocked in ten colors to provide correct phase identification.

CABLE AMPACITY RATINGS IN 40° AMBIENT		
CABLE SIZE	90° C	125° C
4/0 MCM	364 AMPS	451 AMPS
313 MCM	513 AMPS	636 AMPS
373 MCM	548 AMPS	669 AMPS
444 MCM	642 AMPS	796 AMPS
535 MCM	724 AMPS	898 AMPS
646 MCM	814 AMPS	1009 AMPS
777 MCM	916 AMPS	1135 AMPS

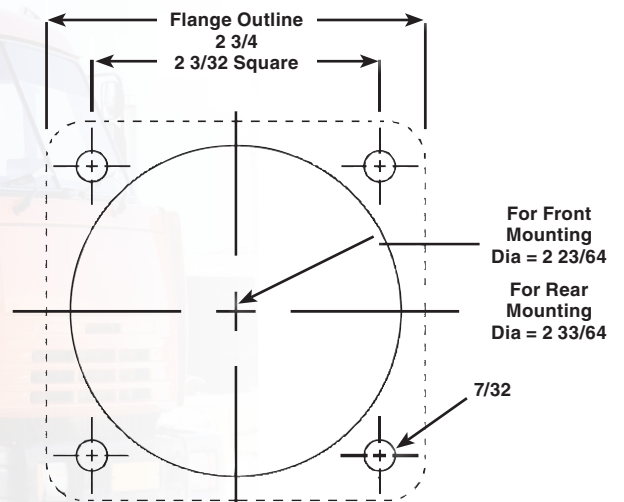



HP20® SERIES

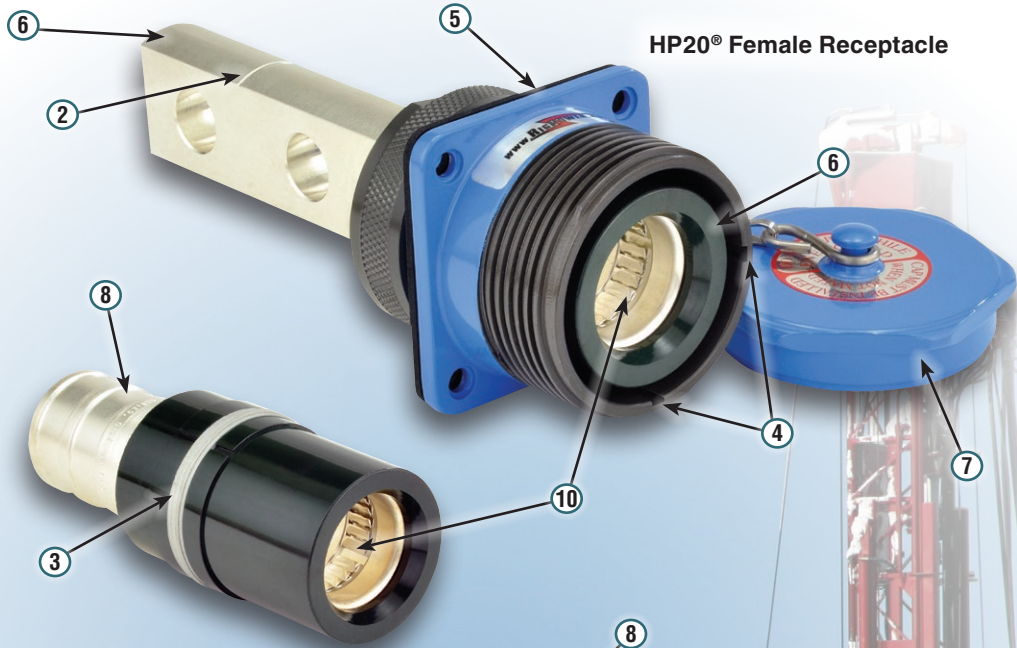

HP20® Female Receptacle



HP20® Male Receptacle

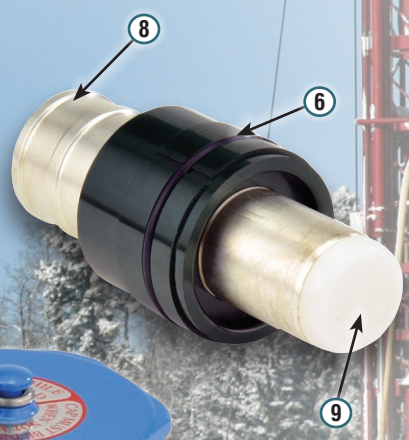

HP20® Cable Adaptor with Internal Insulating Sleeve

HP20® Internal Mylar Insulating Sleeve

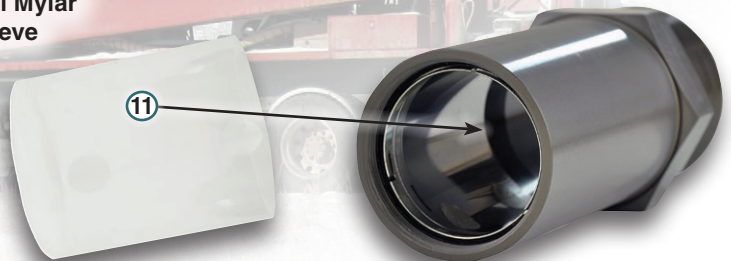



HP20® SERIES RECEPTACLES



HP20® Series
Female Panel Mounted
Receptacle

HP20® Series
Male Panel Mounted
Receptacle

1000 Volts AC/DC
400-1135 Amps
Class 1 Div.2



FEATURES-SPECIFICATIONS

Receptacles

- 1 **ACME threads** – Quick acting double lead ACME threads for rapid yet secure connections.
- 2 **Buss Bar style back** – robust style back provides for larger current loads.
 - » Installation and breakdown is quick and reliable
 - » Double Hole Buss Bar with cut indicator in the event a single hole buss bar is required
 - » Made from high conductivity copper, Sn coated
- 3 **Elastomeric Ring** – The HP20® series is the smallest connector on the market that will accept 777 MCM cable. The combination shear and sealing elastomeric ring reduces the radial distance needed for the insulation between the OD of the copper contact and the ID of the connector body while providing safe operation at up to 1000 volts. This design allows for a size 20 shell to contain a full size contact capable of carrying the full amperage of 777 MCM cable. The 1100 amp rating of the contact assures complete reliability and full load rating.
- 4 **Matching Two Key** – The HP20® Series have a matching two key way to assist with the mounting of the mating component.
- 5 **Neoprene gasket** – Provided on all receptacles.

6 O-Ring Seal

- » Each contact, buss bar and receptacle insulator has an O-Ring Seal designed into the body which offers improved mounting between the electrical component and the insulator or the insulator and cable adapter shell and receptacle housing.
- » Additionally, the O-Ring provides a water tight seal so that the components won't have the propensity to short or burn out, even when the cap is not installed.

7 Receptacle Cap

- » Heavy duty stainless steel chain and clips to prevent loss of cap
- » Powder Coated for easier phase identification at hook-up

Internal Features

The advanced HP20® design techniques utilized by RigPower have allowed us to design in two O-Rings (Contact to Insulator and Insulator to Cable Adapter) at the optimum locations to create a water tight seal.

- Rugged machined aluminum shell with a hard anodized coating is resistant to salt corrosion, drilling mud, humidity, moisture, oil and dust
- Heavy-Duty ACME Threaded Coupling permits positive and quick engagement even under harsh conditions

8 Advanced Crimping System

– The HP20® Series connectors are designed to use the standard hex crimp seen on all RigPower products. This standard crimp design provides a more robust and durable crimp and standardizes the tools needed. One set of four hex die sizes will accommodate all RigPower contacts from 4/0 to 777 MCM cables.

9 Dead front end

– Made from Sn plated high conductivity copper. All male plugs and receptacles have a dead front end to protect operators from shock hazard.

10 Multilam Contact System

- » Low Mating & Unmating Force permits ease of insertion and withdrawal. The HP20® series connectors use the Multilam Contact System. The Multilam Louver Strip allows electrical contact to be made via a large number of defined, current carrying contact points.
- » High resistance to heat
- » High electrical and thermal conductivity
- » Sufficiently high contact forces
- » High number of contact cycles
- » Excellent resistance to corrosion
- » Resistance to vibration
- » Long product life

- Copper Alloy, Sn Plated Contacts and Buss Bars provide maximum conductivity
- Color Coding Option for positive phase identification

11 HP20® Cable Adaptor w/ Internal Insulating Sleeve

– The extra-long barrel and the design of the internally insulated cable adaptor allows no “line of sight” between the copper contact and the internal of the metal shell. This allows a full sized 777 MCM crimp well to be safely contained in the smaller Size 20 connector shell.

HP20® PANEL MOUNT RECEPTACLES – Ordering Format: HP20-(1)-(2)			
(1) RECEPTACLE GENDER		(2) COLOR	
CATALOG NUMBER	DESCRIPTION	CATALOG NUMBER	DESCRIPTION
MBR	Male Double Hole Buss Bar Panel Mount Receptacle	BK	Black
FBR	Female Double Hole Buss Bar Panel Mount Receptacle	BL	Blue
		BR	Brown
		G	Green
		GY	Gray
		OR	Orange
		P	Purple
		R	Red
		W	White
		Y	Yellow





HP20® SERIES

HP20® SERIES PLUGS



FEATURES-SPECIFICATIONS

- 1 #20 Size Mounting Flange**
- 2 ACME threads** – Quick acting double lead ACME threads for rapid, yet secure, connections.
- 3 Coupling Nut**
 - » Note the locking screw on the coupling nut provides for severe service environments
 - » Includes internal O-ring seals to prevent moisture
- 4 Dead Front End** – Made from Sn plated high conductivity copper. The male contacts have a dead front end to protect operators from shock hazard.
- 5 Fixed Cable Receptacle Cap** – Fully powder coated, helps protect roughnecks by identifying proper phase color easily, up close or from a distance. Heavy duty stainless steel chain and clips to prevent loss of cap.
- 6 Hex Grip** – Robust Hex grip for easy assembly and handling. Fully anodized to resist salt corrosion, drilling mud, humidity, moisture, oil and dust.
- 7 Mechanical Cable Clamp or Kellems® Grip** – Cable Plugs can accommodate either a Mechanical Cable Clamp or Kellems® Grip.
- 8 Multilam Contact System** – The HP20® Series Female Receptacles use the Multilam Contact System. The Multilam Louver Strip allows electrical contact to be made via a large number of defined, current carrying contact points.
 - » High resistance to heat
 - » High electrical and thermal conductivity
 - » Sufficiently high contact forces
 - » High number of contact cycles
 - » Excellent resistance to corrosion
 - » Resistance to vibration
 - » Long product life
- 9 Neoprene gasket provided**
- 10 Plug Cap** – Fully powder coated, helps protect roughnecks by identifying proper phase color easily, up close or from a distance. Heavy duty stainless steel chain and clips to prevent loss of cap.

HP20® PLUGS, IN-LINE RECEPTACLES & FIXED CABLE RECEPTACLES – Ordering Format: HP20-(1)-(2)-(3)-(4)-(5)				
(1) MALE & FEMALE CONTACT SIZE	(2) STYLE OF PLUG CASING	(3) GROMMET	(4) MECHANICAL CLAMP	(5) COLOR
Male	P = Plug OR IR = In-Line Receptacle OR FCR = Fixed Cable Receptacle	16 = 0.870 - 1.000	M = Mechanical Clamp	BK = Black
4/0M = 4/0 Male Contact		18 = 1.000 - 1.125	OR	BL = Blue
3M = 313 Male Contact		20 = 1.125 - 1.250	Kellems Grip	BR = Brown
4M = 444 Male Contact		22 = 1.250 - 1.375		GY = Gray
5M = 535 Male Contact		24 = 1.375 - 1.500		OR = Orange
6M = 646 Male Contact				P = Purple
7M = 777 Male Contact			K16 = #16 (0.875 - 1.000)	R = Red
Female		K18 = #18 (1.000 - 1.125)	W = White	
4/0F = 4/0 Female Contact		K20 = #20 (1.125 - 1.250)	Y = Yellow	
3F = 313 Female Contact		K22 = #22 (1.250 - 1.375)		
4F = 444 Female Contact		K24 = #24 (1.375 - 1.500)		
5F = 535 Female Contact				
6F = 646 Female Contact				
7F = 777 Female Contact				

CONNECTORS

HP20® SERIES



HP20® SERIES FIXED CABLE AND IN-LINE RECEPTACLE CONNECTIONS



*Kellems®, is a Registered Trademark of Hubbell Inc.





IN-LINE RECEPTACLE CONNECTIONS



HP20® Fixed In-line Connection

HP20® Plug

HP20® Fixed Cable Receptacle



HP20® In-line Connection

HP20® In-line Receptacle

HP20® Plug



ACCESSORIES



Mechanical Clamp

Has a dual holding pattern. One size for larger cables, reverse it and it accommodates smaller cables more effectively.



30° - 45° Reversible Locking Buss Bar Lug

The small footprint of the HP20® panel mounted receptacles, combined with the RigPower exclusive locking lug allows the designed to combine a small foot print on the panel with short radius cable bends behind the panel while ensuring that shock or vibration loads will not loosen the plug to buss bar connection

Kellems® Grip

Also available for extra protection from high tensile loads on cables.



ORDERING TABLE FOR HP20® SINGLE POLE POWER CONNECTORS – (Rated for 1000 Volts / 1135 Amps)

RIGPOWER HP20® SERIES SINGLE POLE – SPARE PARTS

PART NUMBER	PART DESCRIPTION	PART NUMBER	MALE PART DESCRIPTION	
G16-20	Grommet #16 (0.875 - 1.000)	HP20-4/0M	HP20 - 4/0 Male Contact w/Insulator	
G18-20	Grommet #18 (1.000 - 1.125)	HP20-2M	HP20 - 373 Male Contact w/Insulator	
G20-20	Grommet #20 (1.125 - 1.250)	HP20-3M	HP20 - 313 Male Contact w/Insulator	
G22-20	Grommet #22 (1.250 - 1.375)	HP20-4M	HP20 - 444 Male Contact w/Insulator	
G24-20	Grommet #24 (1.375 - 1.500)	HP20-5M	HP20 - 535 Male Contact w/Insulator	
GW24-20	Grommet Washer #24 (for #20 Shell)	HP20-6M	HP20 - 646 Male Contact w/Insulator	
K16-20	Kellems Grip #16 (0.875 - 1.000)	HP20-7M	HP20 - 777 Male Contact w/Insulator	
K18-20	Kellems Grip #18 (1.000 - 1.125)	HP20-MBB	HP20 - Male Buss Bar w/Insulator	
K20-20	Kellems Grip #20 (1.125 - 1.250)	PART NUMBER	FEMALE PART DESCRIPTION	
K22-20	Kellems Grip #22 (1.250 - 1.375)	HP20-4/0F	HP20 - 4/0 Female Contact w/Insulator	
K24-20	Kellems Grip #24 (1.375 - 1.500)	HP20-2F	HP20 - 373 Female Contact w/Insulator	
MC24-20	Mechanical Clamp #24 (for #20 Shell)	HP20-3F	HP20 - 313 Female Contact w/Insulator	
 <p>CABLE GROMMET Has a tapered fit to the cable adapter and is available in fourteen sizes to ensure a proper water tight seal to the cable.</p>		HP20-4F	HP20 - 444 Female Contact w/Insulator	
			HP20-5F	HP20 - 535 Female Contact w/Insulator
			HP20-6F	HP20 - 646 Female Contact w/Insulator
			HP20-7F	HP20 - 777 Female Contact w/Insulator
			HP20-FBB	HP20 - Female Buss Bar w/Insulator
			PART NUMBER	DOUBLE HOLE LUGS
PART NUMBER	THE 30°/45° REVERSIBLE LOCKING BUSS BAR LUG	PART NUMBER	DOUBLE HOLE LUGS	
SL-535-AL	535 MCM 30°/45° Reversible Locking Buss Bar Lug	QS-535-L	Quick/Quad Stab Double Hole 535 Lug	
SL-646-AL	646 MCM 30°/45° Reversible Locking Buss Bar Lug	QS-646-L	Quick/Quad Stab Double Hole 646 Lug	
SL-777-AL	777 MCM 30°/45° Reversible Locking Buss Bar Lug	QS-777-L	Quick/Quad Stab Double Hole 777 Lug	

*Kellems®, is a Registered Trademark of Hubbell Inc.



Hubbell Harsh & Hazardous Contact Details

United States

Killark

2112 Fenton Logistics Park Blvd.
Fenton, Missouri 63026
Tel: (314) 531-0460 • Fax: (314) 531-7164
www.hubbell-killark.com
Email: killarkinfo@hubbell.com

RigPower (Hawke International)

4140 World Houston Parkway, Suite 130
Houston, TX 77032
Tel: (281) 445-7400 • Fax: (281) 445-7404
Email: rigpowerinfo@hubbell.com

Vantage Technology

4140 World Houston Parkway, Suite 130
Houston, TX 77032
Tel: (281) 445-7400 • Fax: (281) 445-7404
Email: xpsales@vantageexp.com

Canada

Hubbell Canada LP

870 Brock Road South
Pickering, Ontario
Canada L1W 1Z8
Tel: (905) 839-1139 • Fax: (905) 839-9108
Email: infohclp@hubbell-canada.com

Mexico

Hubbell Products Mexico

Calle 5 Sur No. 105 Col. Parque
Ind. Toluca 2000
Toluca Edo. Mex. CP 50200
Tel: (01 52) 559-151-9999 • Fax: (01 52) 559-151-9988/89
www.hubbell.com.mx
Email: info@hubbell.com.mx

United Kingdom

Hubbell Products

Brunel Drive
Stretton Park Burton on Trent
Straffordshire DE13 0BZ UK
Tel: +44 (0) 1283 500500 • Fax: +44 (0) 1283 500400
Email: Sales@hubbell.co.uk

Victor Lighting

PO Box 5571
Glasgow G52 9AH Scotland
Tel: +44 (0) 141 810 9644 • Fax: +44 (0) 141 810 9642
www.victor-lighting.com

Chalmit Lighting

PO Box 5575
Glasgow G52 9AP Scotland
Tel: +44 (0) 141 882 5555 • Fax: +44 (0) 141 883 3704
www.chalmit.com

Middle East

Office #432, Bldg #6EB
Dubai Airport Free Zone (DAFZ) • PO Box 23529 Dubai UAE
Tel: +971 (0) 4 609 1222 • Email: killarkinfo@hubbell.com

Asia Pacific

130 Joo Seng Road, #03-02, Olivine Building
Singapore 368357
Tel: 00 65 6282 2242 • Fax: 00 65 6284 4244
Email: killarkinfo@hubbell.com

Korea

512 Hyosung Intellian 681-3 Deungchon Dong
Kangseo-Ku Seoul 157-030 Korea
Tel: +82 2 2063 3719 • Fax: +82 2 2603 7386
Email: killarkinfo@hubbell.com

China

Room H/I 18F No. 728 Pudong Avenue
Shanghai International Ocean and Finance Building
Shanghai 20120 P.R. China
Tel: (86 21) 3392 6550 ext. 318 • Fax (86 21) 3392 6551
Email: killarkinfo@hubbell.com



KILLARK[®]

2112 Fenton Logistics Park Blvd.
Fenton, MO 63026
TEL: (314) 531-0460
www.hubbell-killark.com • killarkinfo@hubbell.com

Hubbell Canada LP
870 Brock Road South
Pickering, Ontario L1W 1Z8
(905) 839-1138
infohclp@hubbell-canada.com

Hubbell Products Mexico
Calle 5 Sur No. 105 Col. Parque
Ind. Toluca 2000
Toluca Edo. Mex. CP 50200
Tel: (01 52) 559-151-9999
info@hubbell.com.mx

Hubbell[®] Construction and Energy

A Division of Hubbell, Inc.
HKMC-CONN 01-20 © Killark, 2020